

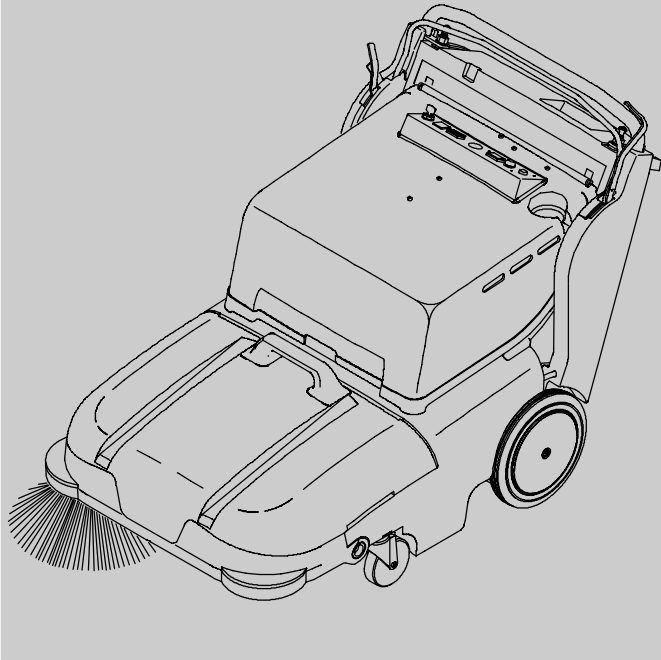

# 3640

(Gas/LPG)

## Sweeper Operator Manual



**North America / International**

[www.tennantco.com](http://www.tennantco.com)

**330580**  
**Rev. 06 (02-2008)**





This manual is furnished with each new model. It provides necessary operation and maintenance instructions.

**Read this manual completely and understand the machine before operating or servicing it.**

This machine will provide excellent service. However, the best results will be obtained at minimum costs if:

- The machine is operated with reasonable care.
- The machine is maintained regularly - per the machine maintenance instructions provided.
- The machine is maintained with manufacturer supplied or equivalent parts.

	<b>PROTECT THE ENVIRONMENT</b> Please dispose of packaging materials, old machine components such as batteries, hazardous fluids including antifreeze and oil, in an environmentally safe way according to local waste disposal regulations.
	Always remember to recycle.

<b>MACHINE DATA</b>	
Please fill out at time of installation for future reference.	
Model No. -	_____
Serial No. -	_____
Machine Options -	_____
Sales Rep. -	_____
Sales Rep. phone no. -	_____
Customer Number -	_____
Installation Date -	_____

**Tennant Company**

PO Box 1452

Minneapolis, MN 55440

Phone: (800) 553-8033 or (763) 513-2850

[www.tennantco.com](http://www.tennantco.com)



**CALIFORNIA PROPOSITION 65 WARNING:**

**Engine exhaust from this product contains chemicals known to the State of California to cause cancer, birth defects, or other reproductive harm.**

Specifications and parts are subject to change without notice.

Original instructions, Copyright © 2000, 2001, 2002, 2003, 2004, 2005, 2006, 2008 TENNANT Company, Printed in U.S.A.

**CONTENTS**

	Page		Page
SAFETY PRECAUTIONS .....	3	SKIRTS AND SEALS .....	37
OPERATION .....	5	MAIN BRUSH SKIRTS .....	37
OPERATOR RESPONSIBILITY .....	5	HOPPER DUST SEAL .....	37
MACHINE COMPONENTS .....	7	REAR SKIRT .....	37
SYMBOL DEFINITIONS .....	8	HOPPER LIP SKIRT .....	38
CONTROLS AND INSTRUMENTS .....	9	FILTER COMPARTMENT	
OPERATION OF CONTROLS .....	10	DOOR SEAL .....	38
DIRECTIONAL CONTROL LEVER ...	10	VACUUM INLET PLATE .....	38
CLUTCH HANDLE .....	12	CLEANING THE PANEL FILTER .....	39
MAIN BRUSH LEVER .....	12	BRUSHES .....	40
SIDE BRUSH LEVER .....	13	MAIN BRUSH .....	40
ENGINE CHOKE KNOB .....	13	REPLACING THE MAIN BRUSH ..	40
LOW OIL WARNING INDICATOR ....	13	CHECKING AND ADJUSTING MAIN	
LOW BATTERY CHARGE		BRUSH PATTERN .....	42
INDICATOR .....	14	ROTATING THE MAIN BRUSH ....	43
STEERING BAR .....	14	SIDE BRUSH(ES) .....	44
STEERING BAR ADJUSTMENT		REPLACING THE SIDE	
KNOBS .....	14	BRUSH(ES) .....	44
IGNITION KEY SWITCH .....	15	ELECTRIC MOTORS .....	44
HOURMETER .....	15	BELTS AND CHAINS .....	45
VACUUM WAND .....	15	VACUUM FAN BELT .....	45
CIRCUIT BREAKER .....	16	MAIN BRUSH BELT .....	45
THERMO SENTRY™ .....	16	STATIC DRAG CHAIN .....	45
FILTER SHAKER SWITCH .....	16	CLUTCH CABLE .....	45
HOW THE MACHINE WORKS .....	17	TIRES .....	46
PRE-OPERATION CHECKLIST .....	17	PUSHING AND TRANSPORTING	
CHANGING AN LPG TANK .....	19	THE MACHINE .....	47
STARTING THE MACHINE .....	21	PUSHING THE MACHINE .....	47
SWEEPING AND BRUSH		TRANSPORTING THE MACHINE ..	47
INFORMATION .....	22	STORING MACHINE .....	49
SWEEPING .....	23	SPECIFICATIONS .....	50
STOP SWEEPING .....	24	GENERAL MACHINE	
EMPTYING THE DEBRIS HOPPER .....	26	DIMENSIONS/CAPACITIES .....	50
STANDARD HOPPER .....	26	GENERAL MACHINE PERFORMANCE ...	50
HOPPER DUMP ASSIST		POWER TYPE .....	51
HANDLE (OPTION) .....	27	ELECTRIC MOTORS .....	51
REPLACING THE BAG FILTER .....	28	TIRES .....	51
CLEANING THE FILTER		MACHINE DIMENSIONS .....	52
COMPARTMENT .....	29	INDEX .....	53
POST-OPERATION CHECKLIST .....	30		
OPERATION ON INCLINES .....	30		
OPTIONS .....	31		
WIDE TRACK TIRES AND HEAVY DUTY			
CASTERS .....	31		
MACHINE TROUBLESHOOTING .....	32		
MAINTENANCE .....	33		
MAINTENANCE CHART .....	33		
LUBRICATION .....	34		
ENGINE .....	34		
HEAVY DUTY CASTERS (OPTION) ..	34		
FUEL SYSTEM .....	35		
FUEL FILTER AND SEDIMENT BOWL	35		
GAS VALVE .....	35		
ENGINE .....	36		
AIR FILTER .....	36		
SPARKPLUG .....	36		



## SAFETY PRECAUTIONS

The following symbols are used throughout this manual as indicated in their description:



**WARNING:** To warn of hazards or unsafe practices that could result in severe personal injury or death.

**FOR SAFETY:** To identify actions that must be followed for safe operation of equipment.

The machine is suited to sweep disposable debris. Do not use the machine other than described in this Operator Manual. The machine is not designed for use on public roads.

The following information signals potentially dangerous conditions to the operator or equipment:



**WARNING:** Heavy hopper. Get help to handle.



**WARNING:** Brush throws debris. Stop motor before lifting hopper.



**WARNING:** Moving belt and fan. Keep away.



**WARNING:** Engine emits toxic gases. Severe respiratory damage or asphyxiation can result. Provide adequate ventilation. Consult with your regulatory agency for exposure limits. Keep engine properly tuned.

#### FOR SAFETY:

1. **Do not operate machine:**
  - Unless trained and authorized.
  - Unless operation manual is read and understood.
  - In flammable or explosive areas unless designed for use in those areas.
2. **Before starting machine:**
  - Check for fuel leaks.
  - Keep sparks and open flame away from refueling area.
  - Make sure all safety devices are in place and operate properly.
3. **When using machine:**
  - Do not pick up burning or smoking debris, such as cigarettes, matches or hot ashes
  - Go slowly on inclines and slippery surfaces.
  - Use care when reversing machine.
  - Do not carry riders on machine.
  - Always follow safety and traffic rules.
  - Report machine damage or faulty operation immediately.
4. **Before leaving or servicing machine:**
  - Stop on level surface.
  - Move directional lever into Park position.
  - Turn off machine and remove key.
5. **When servicing machine:**
  - Avoid moving parts. Do not wear loose jackets, shirts, or sleeves when working on machine.
  - Use hoist or jack that will support the weight of the machine.
  - Wear eye and ear protection if using pressurized air or water.
  - Disconnect battery connections before working on machine.
  - Keep flames and sparks away from fuel system service area. Keep area well ventilated.
  - Avoid contact with battery acid.
  - Use Tennant supplied or equivalent replacement parts.
6. **When loading/unloading machine onto/off truck or trailer:**
  - Turn off machine.
  - Use truck or trailer that will support the weight of the machine.
  - Use winch. Do not push the machine onto/off the truck or trailer unless the load height is 380 mm (15 in) or less from the ground.
  - Block machine tires.
  - Tie machine down to truck or trailer.

# SAFETY PRECAUTIONS

The following safety labels are mounted on the machine in the locations indicated. If these or any labels become damaged or illegible, install a new label in its place.

**FOR SAFETY LABEL - LOCATED ON THE CONTROL PANEL**

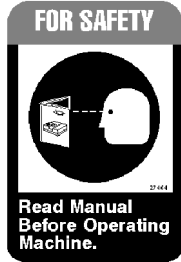

**TOXIC GASES LABEL - LOCATED ON THE CONTROL PANEL**



**BACK STRAIN LABEL - LOCATED ON THE ENGINE COMPARTMENT COVER**

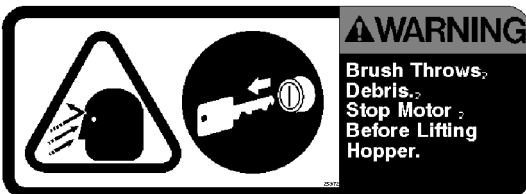

**FLYING DEBRIS WARNING LABEL - LOCATED ON THE MOTOR COMPARTMENT COVER**

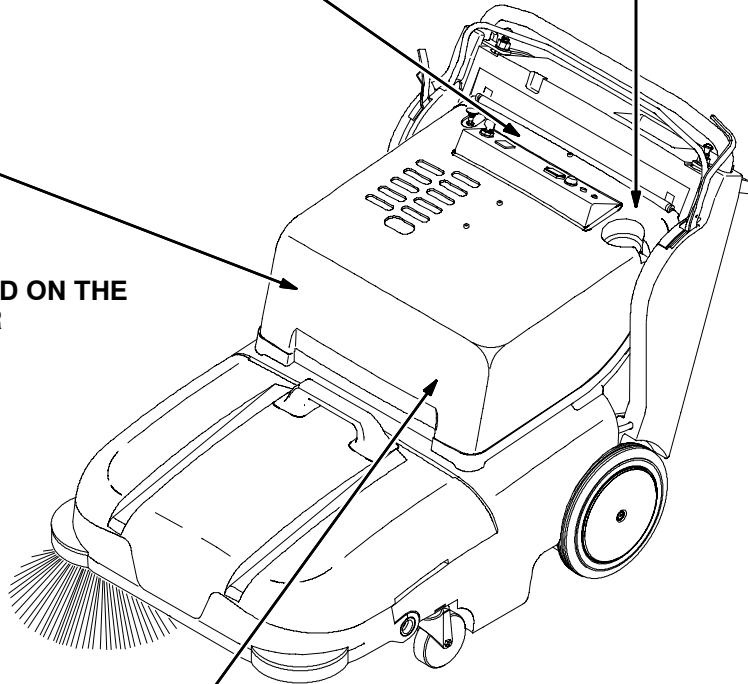

350841

## OPERATION

## OPERATOR RESPONSIBILITY

- The operator's responsibility is to take care of the daily maintenance and checkups of the machine to keep it in good working condition. The operator must inform the service mechanic or supervisor when the maintenance intervals are required as stated in the *MAINTENANCE* section of this manual.
- Read this manual carefully before operating the machine. View the operation video supplied with the machine.

**FOR SAFETY: Do not operate machine, unless operation manual is read and understood.**

- Check the machine for shipping damage. Check to make sure the machine is complete per shipping instructions.
- Change the LPG tank per the *CHANGING AN LPG TANK* section of this manual.
- Fill the gas tank.

**FOR SAFETY: When servicing machine, keep flames and sparks away from fuel system service area. Keep area well ventilated.**

- Check the engine oil.

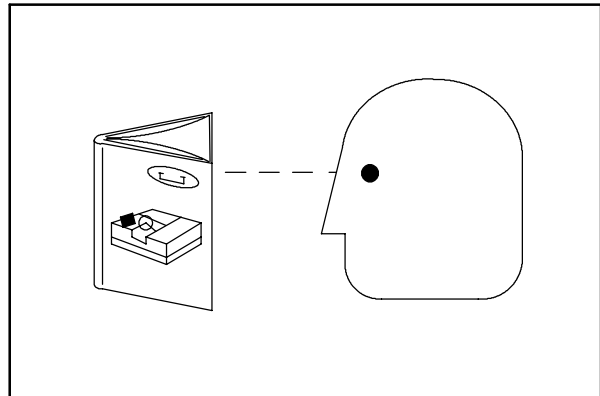

07324

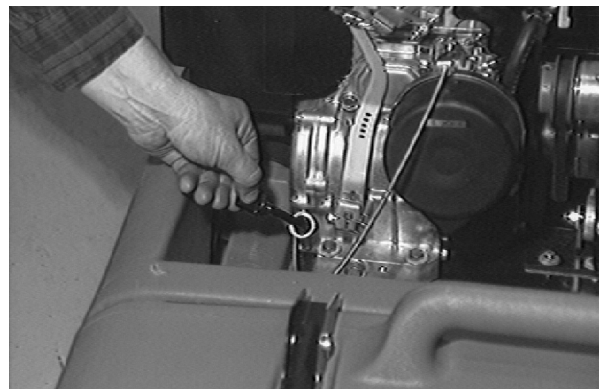
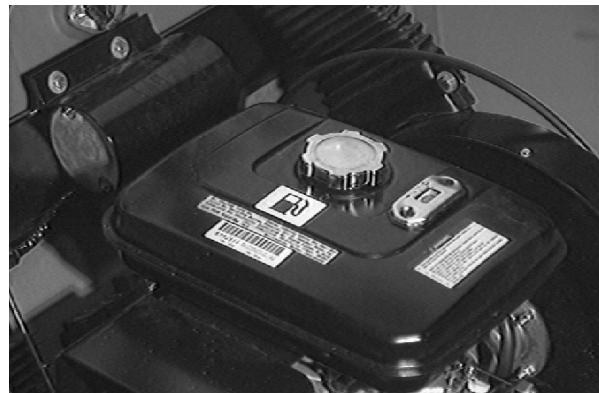

## OPERATION

---

- Keep your machine regularly maintained by following the maintenance information in this manual. We recommend taking advantage of a regularly scheduled service contract from your Tennant representative.
- Order parts and supplies directly from your authorized Tennant representative. Use the parts manual provided when ordering parts.
- After the first 50 hours of operation, follow the recommended procedures stated in the *MAINTENANCE CHART*.

---

**MACHINE COMPONENTS**

---

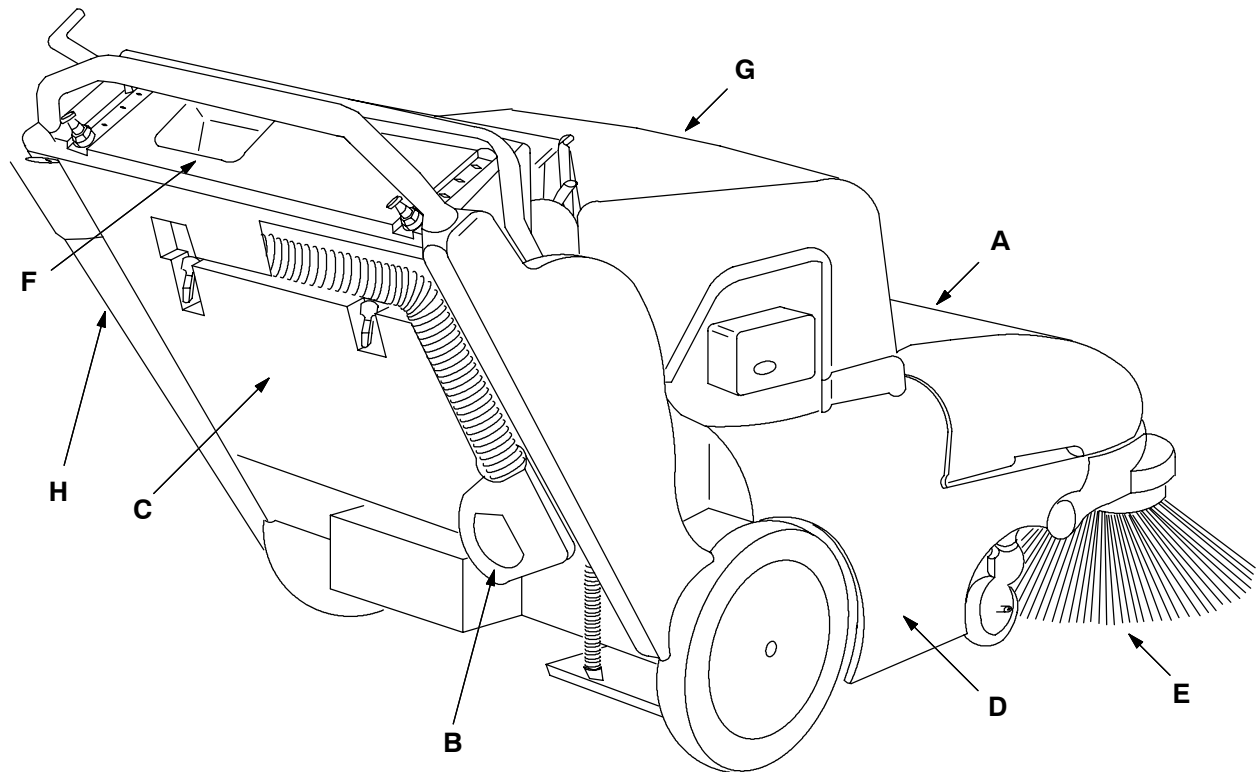

350659

- A. Debris hopper
- B. Vacuum wand (option)
- C. Filter compartment
- D. Main brush
- E. Side brush
- F. Accessory bin
- G. Engine compartment
- H. Vac wand extension (option)

## SYMBOL DEFINITIONS

---

These symbols identify controls, displays, and features on the machine:



Start



Filter shaker switch



Side brush(es) down and on



Side brush(es) up and off



Main brush down pressure



Main brush down and on



Main brush up and off



Low engine oil indicator



Low battery / alternator indicator



Circuit breaker #1

## CONTROLS AND INSTRUMENTS

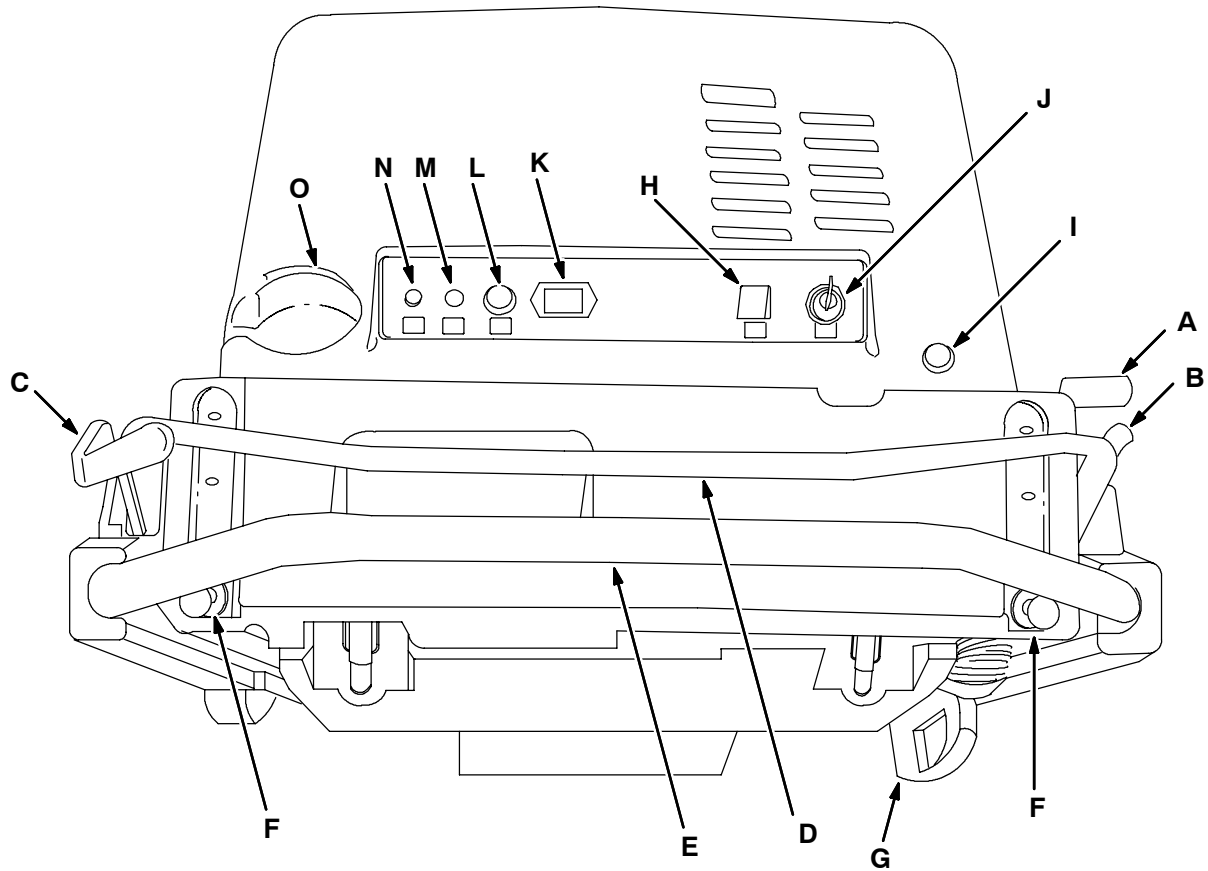

- A. Main brush lever
- B. Side brush lever
- C. Directional control lever
- D. Clutch handle
- E. Steering bar
- F. Steering bar adjustment knobs.
- G. Vacuum wand (option)
- H. Filter shaker switch
- I. Engine choke knob
- J. Ignition key switch
- K. Hourmeter
- L. Circuit breaker
- M. Low battery charge indicator
- N. Low oil warning indicator
- O. Beverage holder

350657

## OPERATION OF CONTROLS

### DIRECTIONAL CONTROL LEVER

The directional control lever controls the machine's speed and direction of travel. The machine has three forward speeds: second, first, and third; one reverse speed; as well as neutral and park settings.

The speed selection pattern is designed to allow the operator to move the control lever quickly between second speed and reverse. The neutral setting is located midway between these positions. Since reverse and second speed will be used most often for routine sweeping, the area between these positions is called the working range. The directional control lever positions are labeled near the base of the directional control lever in the following order:

**PARK:** Pull the directional control lever toward you as far as it will go. The directional control lever should always be in the PARK position when starting, stopping, or leaving the machine unattended while the machine is powered on.

**REVERSE:** Move the directional control lever to the left, then one position forward from the PARK position. The machine will move backward when the clutch handle is squeezed.

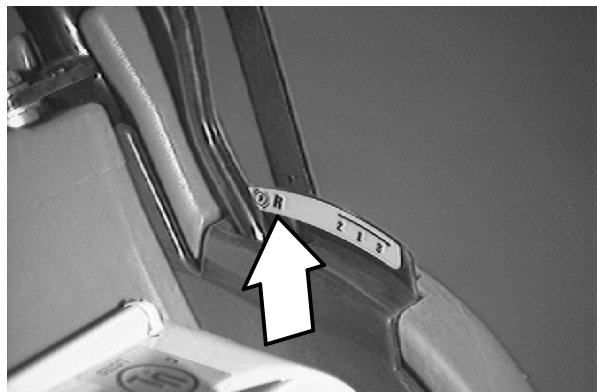
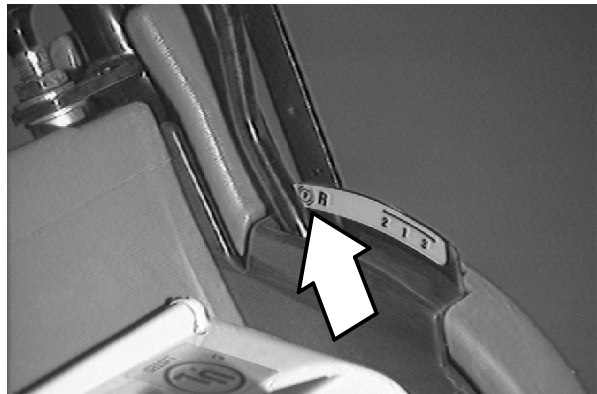
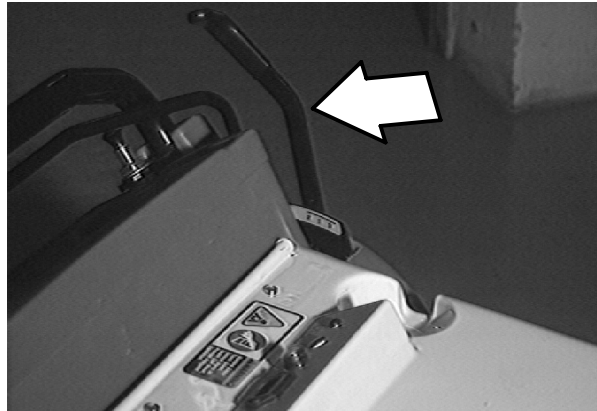

**NEUTRAL:** Push the directional control lever halfway between the REVERSE position and the SECOND SPEED position. The machine will not move forward when the clutch handle is squeezed while in NEUTRAL. Do not leave the machine powered on in NEUTRAL while the machine is unattended.

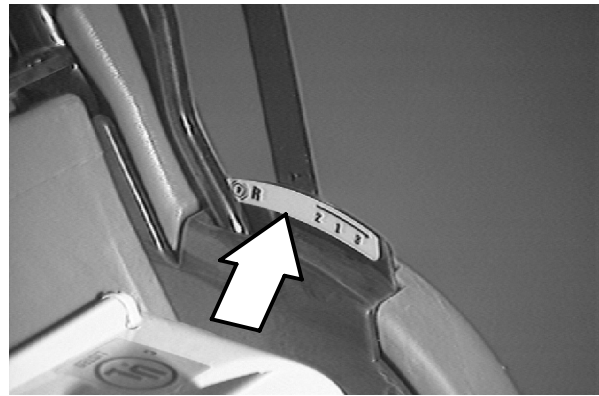

**SECOND SPEED:** Push the directional control lever one position forward from the NEUTRAL position. The machine will move forward when the clutch handle is squeezed. Use SECOND SPEED for normal sweeping.

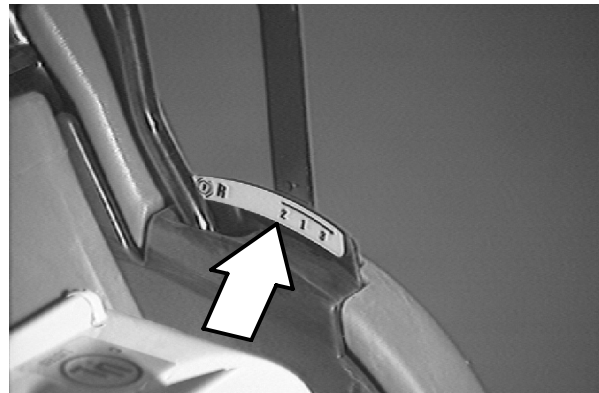

**FIRST SPEED:** Move the directional control lever to the left, then one position forward from the SECOND SPEED position. The machine will move forward when the clutch handle is squeezed. Use FIRST SPEED on inclines and slippery surfaces.

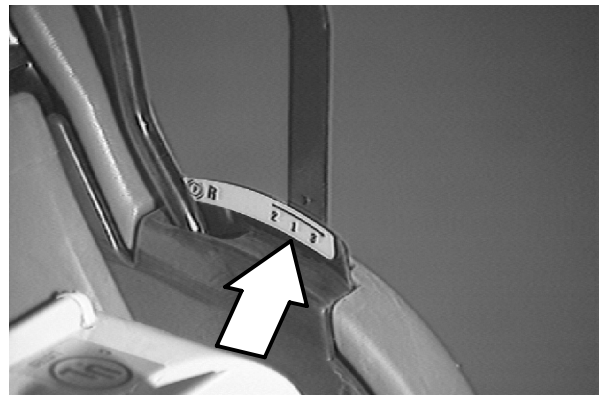

**THIRD SPEED:** Move the directional control lever to the left, then forward as far as it will go. The machine will move forward when the clutch handle is squeezed. Use THIRD SPEED for sweeping in wide open areas or for transport to the dumping area when the hopper is full.

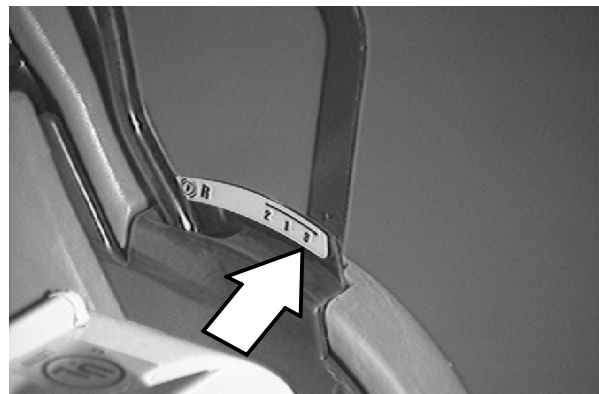

## OPERATION

### CLUTCH HANDLE

The clutch handle engages the machine's propelling system when the direction control lever is positioned in a forward or reverse position. The farther the clutch handle is squeezed toward the steering bar, the faster the machine will travel, up to its maximum in the selected position.

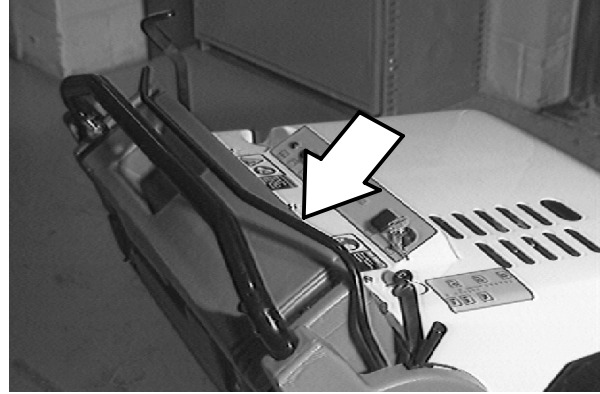

**Braking:** To stop the machine at any time, regardless of direction of travel, release the clutch handle. The machine will immediately slow down, then stop completely.

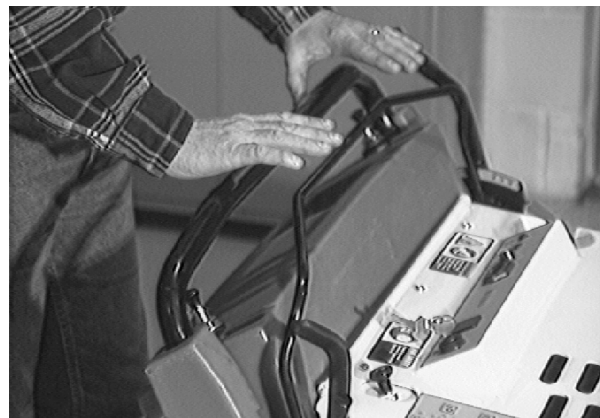

### MAIN BRUSH LEVER

The main brush lever raises and lowers the main brush. The main brush rotates automatically when the machine is powered on. The main brush rotates whether in the raised or lowered position.

**Main brush down:** Move the main brush lever to the left, out of the raised position, then allow it to fall forward into the sweeping position.

**Main brush up:** Move the main brush lever backward, then to the right to raise and set the main brush in the raised position.

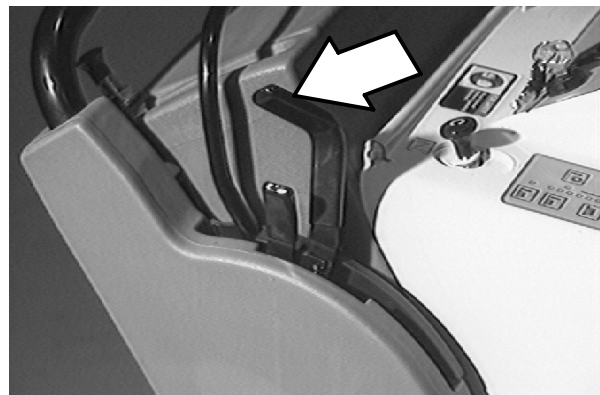

### SIDE BRUSH LEVER

The side brush lever raises and lowers the side brush. The side brush will rotate automatically when lowered. The side brush does not rotate when raised.

Side brush down and on: Move the side brush lever to the right, out the raised position, then forward to the desired brush down pressure setting.

Side brush up and off: Move the side brush lever backward, then to the left to raise and set the side brush in the raised position.

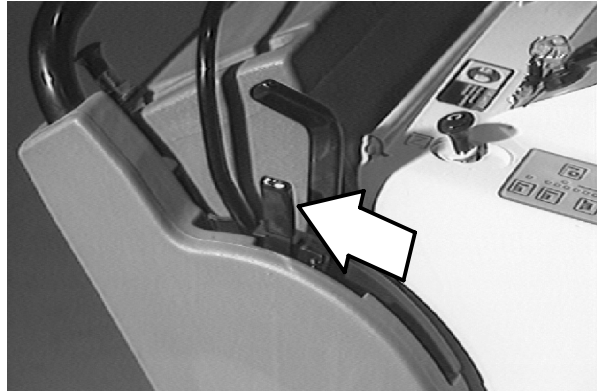

### ENGINE CHOKE KNOB

The engine choke knob controls the choke.

On: For cold starting, pull the engine choke knob out.

Off: Push the choke knob in.

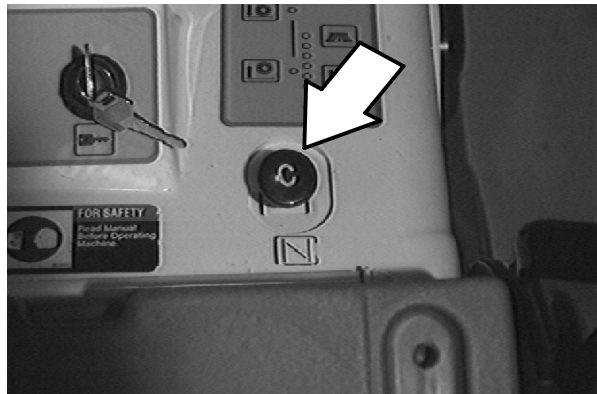

### LOW OIL WARNING INDICATOR

The low oil warning indicator will illuminate when the engine oil level drops below a certain level. When the engine oil level is too low, the engine will automatically shut itself off.

The engine will not restart and the indicator will not go out until the proper amount of engine oil has been added.



## OPERATION

### LOW BATTERY CHARGE INDICATOR

The low battery charge indicator will illuminate when the battery charging system is not functioning properly. If the light remains on after the engine starts, contact TENNANT service personnel.

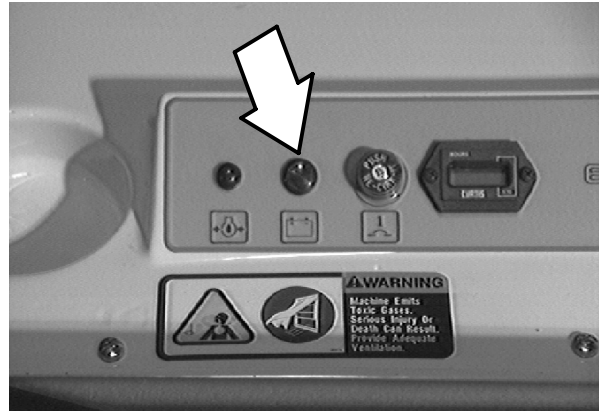

### STEERING BAR

Use the steering bar to steer the machine.

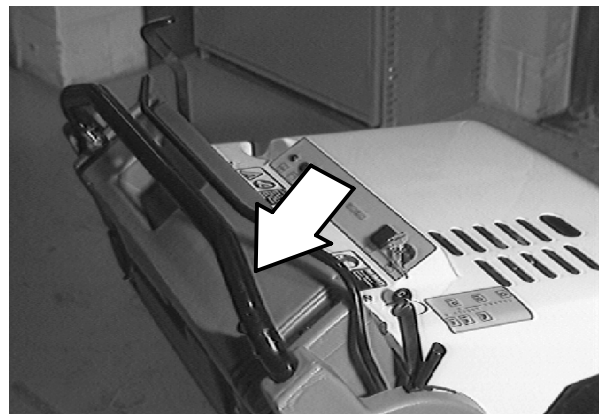

### STEERING BAR ADJUSTMENT KNOBS

The steering bar adjustment knobs allow you to move and lock the steering bar into a position that is most comfortable for you. Pull both adjustment knobs out at once to raise or lower the steering bar.

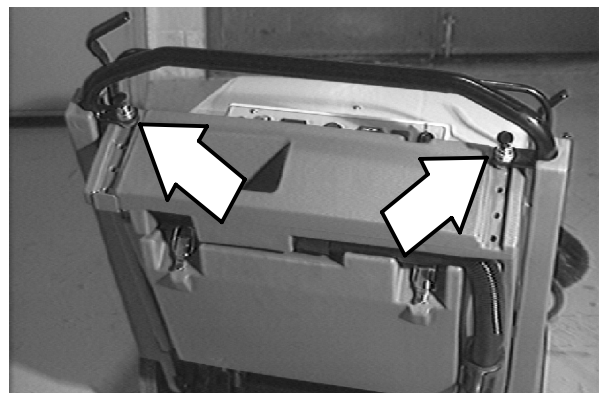

### IGNITION KEY SWITCH

The ignition switch turns the engine on and off using a key.

On: Turn the key clockwise as far as it will go and release it to the on position.

Off: Turn the key counterclockwise.



### HOURMETER

The hourmeter records the number of hours the machine has been in use. Use this information as a guide to indicate when routine maintenance needs to be performed.

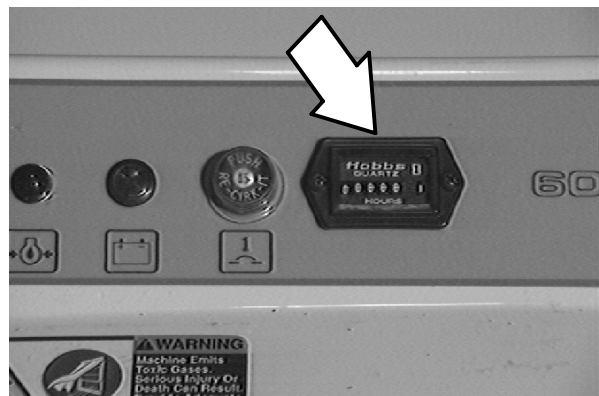

### VACUUM WAND (OPTION)

The vacuum wand uses the machine's vacuum system. Use the vacuum wand to pick up debris in narrow or partially enclosed areas that cannot be swept by the machine. Fully insert the vacuum wand into the machine when not in use.

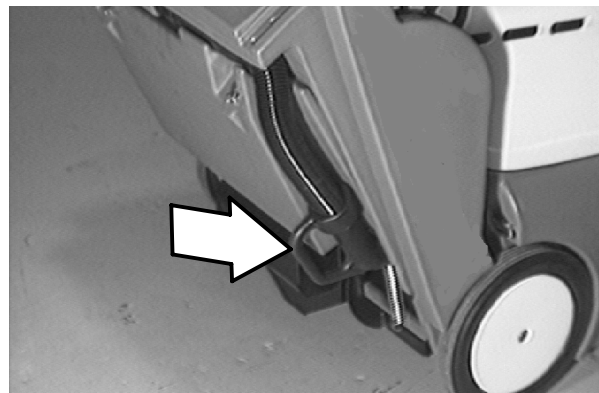

# OPERATION

## CIRCUIT BREAKER

The circuit breaker is a resettable electrical circuit protection device designed to stop the flow of current in the event of a circuit overload. If the circuit breaker is tripped, reset it manually by pressing the reset button after the breaker has cooled down.

If the overload that caused the circuit breaker to trip is still present, the circuit breaker will continue to stop current flow until the problem is corrected.

The circuit breaker is located on the instrument panel.

The chart below shows the circuit breaker and the electrical components it protects.

Circuit Breaker	Rating	Circuits Protected
CB1	15 A	Ignition Side brush(es) Shaker motor

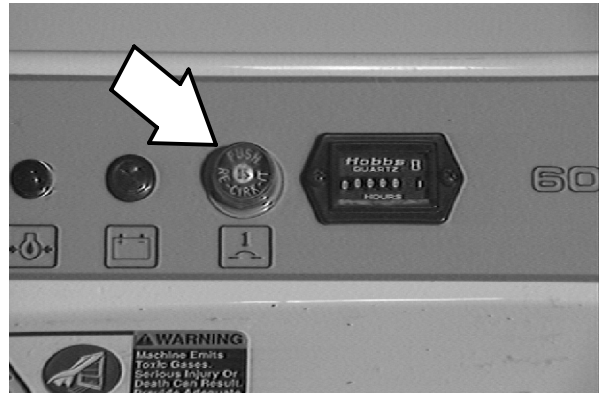

## THERMO SENTRY™

The Thermo Sentry™ will automatically turn the machine's engine off in case of a fire in the hopper. If the Thermo Sentry™ is tripped, it will automatically reset itself after cooling down.

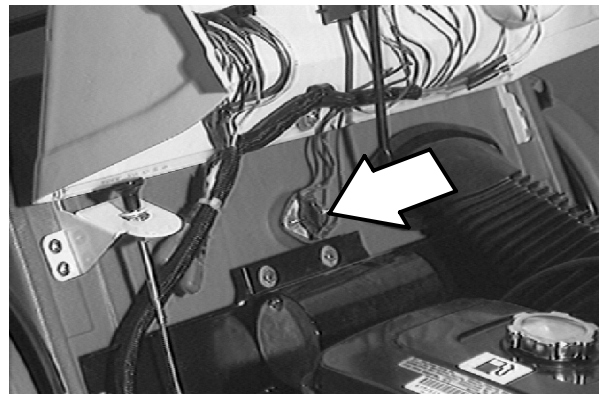

## FILTER SHAKER SWITCH

The filter shaker switch activates the filter shaker motor. The shaker motor shakes debris from the panel filter. Machines with a bag filter do not have a filter shaker motor or switch.

Make sure the filter compartment door is closed properly, then press the switch. The filter shaker motor will shake the filter for 15 seconds, then stop automatically. Remove loose debris from the panel filter compartment door when the shaker motor stops.

*NOTE: The filter shaker will operate while the engine is running. Be sure to turn the engine off before shaking the filter.*

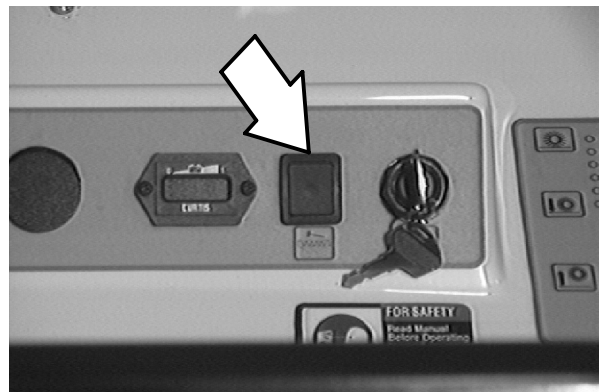

---

## HOW THE MACHINE WORKS

---

The operator steers the machine by using the steering bar. The directional control lever controls the forward or reverse direction of the machine. The clutch handle engages the propelling system when it is squeezed toward the steering bar. The clutch handle will also stop the machine when it is released.

The side brush sweeps debris into the path of the main brush. The main brush sweeps debris from the floor into the hopper. The vacuum system pulls dust and air through the main brush compartment and the dust filter.

When sweeping is finished, press the filter shaker switch (option) to clean the panel filter (option) if the machine has these options. Clean the panel filter compartment. Empty the hopper.

If the machine has a bag filter, check the filter bag and replace if full. Empty the hopper.

---

## PRE-OPERATION CHECKLIST

---

- Check under the machine for fluid leaks (fuel, oil).
- Check fuel level.

**FOR SAFETY: When servicing machine, keep flames and sparks away from fuel system service area. Keep area well ventilated.**

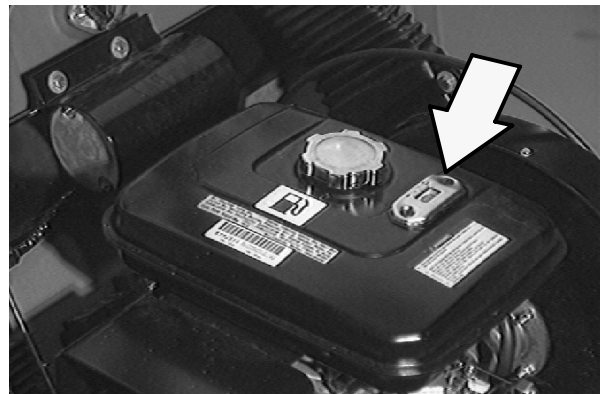

## OPERATION

---

- Check the engine oil level.

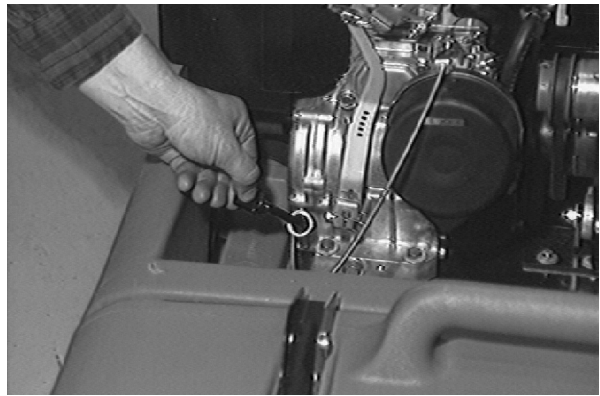

- LPG powered machines: Check for LPG odor or frosting on hoses or components indicating an LPG leak.
- Check controls for proper operation.
- Check maintenance records to determine service requirements.

**CHANGING AN LPG TANK**

1. Stop the machine in a designated safe area with the engine running. Move the directional lever into the PARK position.
2. Close the service valve on the LPG tank.
3. Allow the engine to run until it stops from lack of fuel.

**FOR SAFETY: When servicing machine, keep flames and sparks away from fuel system service area. Keep area well ventilated.**

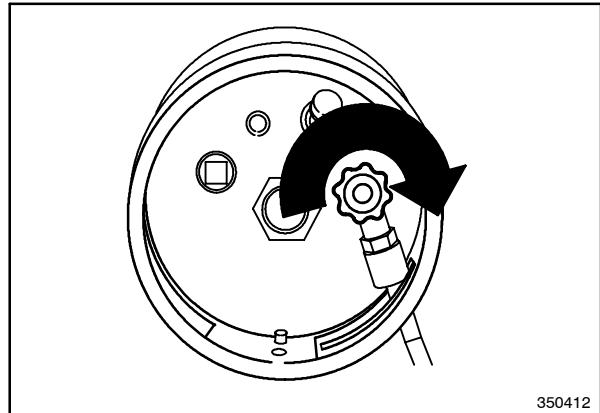

4. Put on gloves to remove the quick-disconnect tank coupling.
5. Unlatch the clamp holding the empty tank. Remove the empty tank from the machine and store it in a designated safe area.

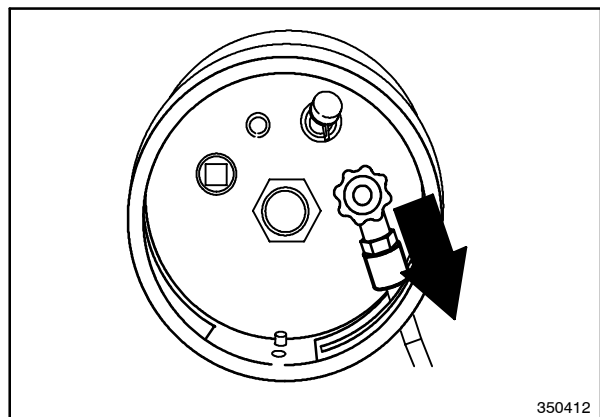

6. Carefully place a full LPG tank into the tank holder. Align the full tank so that the tank centering pin enters the aligning hole in the tank collar.

*NOTE: Make sure the LPG fuel tank matches the fuel system (vapor tank with vapor system).*

7. Latch the security clamp to lock the tank in position.

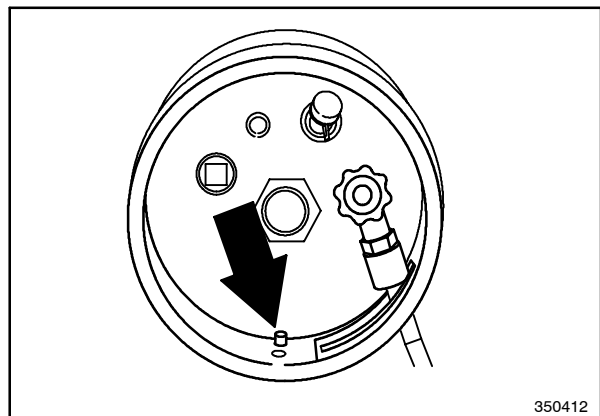

## OPERATION

8. Connect the LPG fuel line to the service coupling. Ensure the service coupling is clean, free of damage, and matches the machine service coupling.

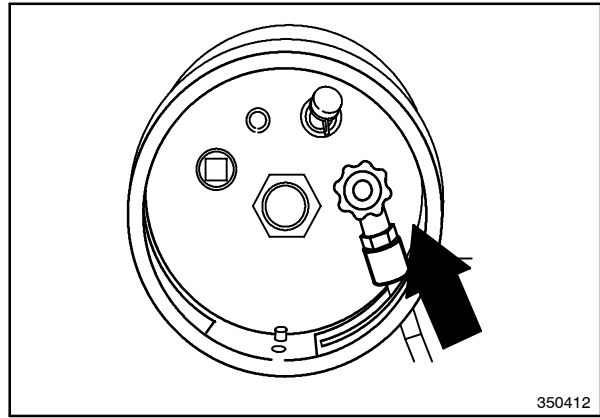

9. Open the tank service valve slowly. Look and listen for leaks. Close the service valve immediately if an LPG leak is found or if a strong LPG odor is detected. Notify the appropriate personnel regarding LPG fuel leaks.

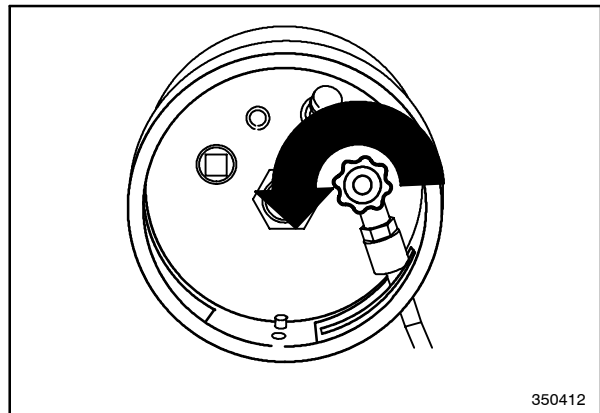

## STARTING THE MACHINE

1. LPG powered machines: Open the tank service valve slowly.

*NOTE: Opening the service valve too quickly may cause the check valve to stop the flow of LPG fuel. If the check valve stops the fuel flow, close the service valve, wait a few seconds and open the valve again more slowly.*

2. If equipped with the vacuum lockoff system;  
For cold and hot starting - Pull out choke and crank engine for 3 to 5 seconds. While continuing to crank engine, slowly push in choke.  
If equipped with the solenoid lockoff system;  
For cold starting - Pull out choke and crank engine, once engine fires push in choke.  
For hot starting - No choking required, simply crank engine.

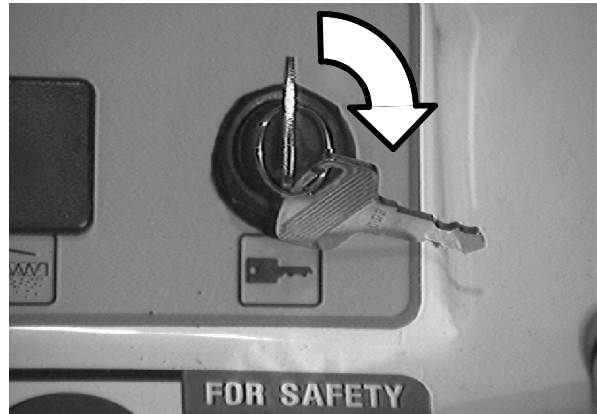

3. Move the directional control lever into the desired forward speed (second, first, or third).

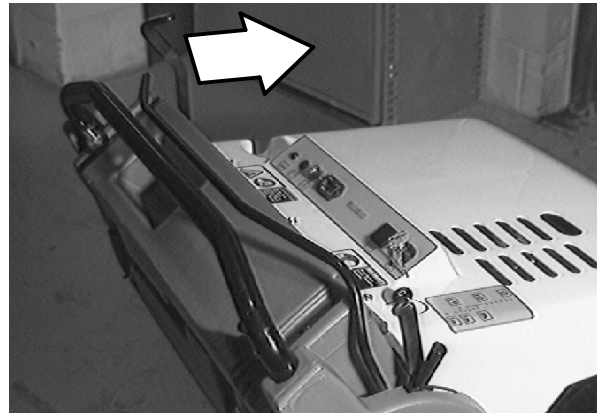

4. Gently squeeze the clutch handle to move the machine forward.

*NOTE: The farther the clutch handle is squeezed toward the steering bar, the faster the machine will travel, up to its maximum in the selected position.*

5. Drive the machine to the area to be swept.

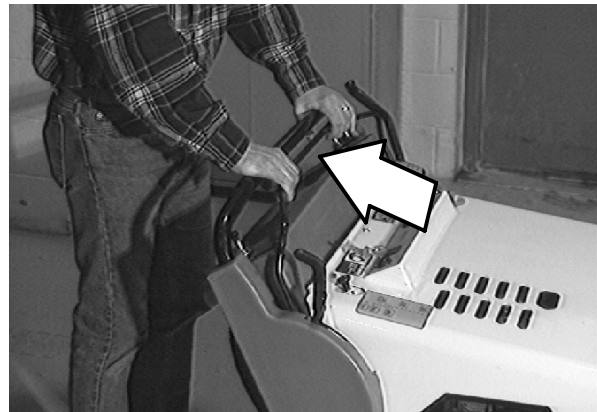

## SWEEPING AND BRUSH INFORMATION

---

Pick up oversized debris before sweeping. Flatten or remove bulky cartons from aisles before sweeping. Pick up pieces of wire, twine, string, etc., which could become entangled in the brushes or brush hub.

Plan the sweeping in advance. Try to arrange long runs with minimum stopping and starting. Sweep debris from very narrow aisles into the main aisles ahead of time. Do an entire floor or section at one time. Drive the straightest path possible. Avoid bumping into posts or scraping the sides of the machine. Overlap the sweeping paths.

***Polypropylene 8-double row main brush*** - Superior pick-up of sand, gravel, and paper litter. Polypropylene retains its stiffness when wet and can be used indoors or outdoors with equal performance.

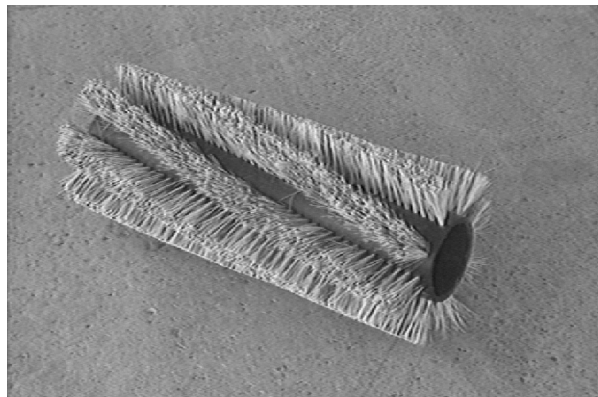

***Polypropylene Side Brush*** - A good general purpose brush for sweeping of light to medium debris in both indoor and outdoor applications. This brush is recommended when bristles may get wet.



---

**SWEEPING**

---

1. Drive the machine to the area to be swept.
2. Release the clutch handle to stop the machine.
3. Move the main brush lever to the left, out of the raised position, then allow it to fall forward into the sweeping position.

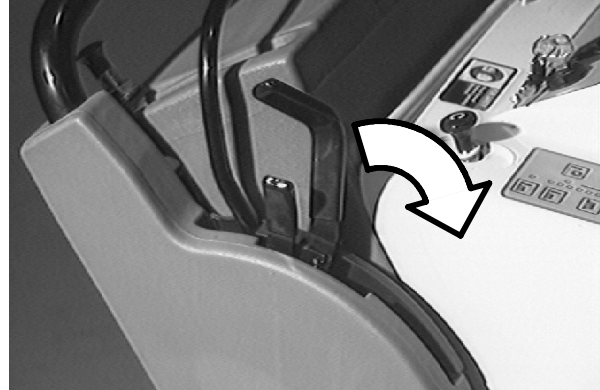

4. Move the side brush lever to the right, out of the raised position, then forward to the desired brush down pressure setting.

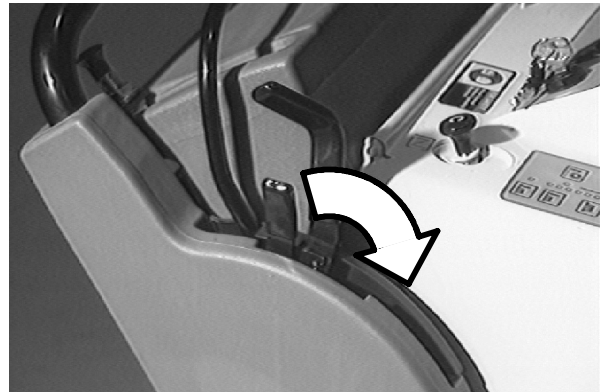

5. Squeeze the clutch handle to begin sweeping.

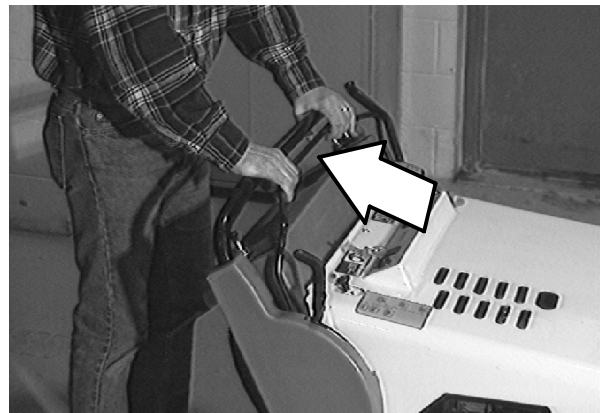

6. Sweep as needed.

## STOP SWEEPING

1. Release the clutch handle.

*NOTE: The machine will immediately slow down, then stop completely.*



2. Move the main brush lever backward, then to the right to raise and set the main brush in the raised position.

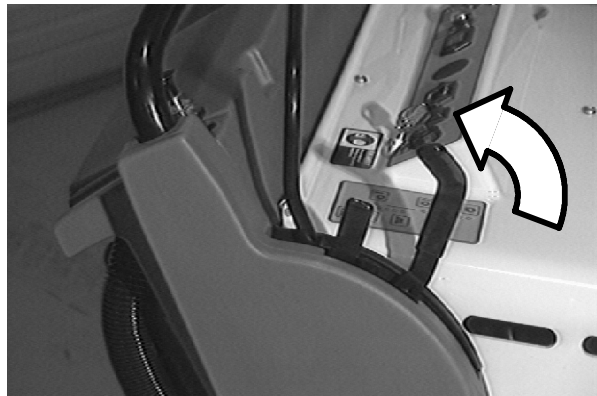

3. Move the side brush lever backward, then to the left to raise and set the side brush(es) in the raised position.

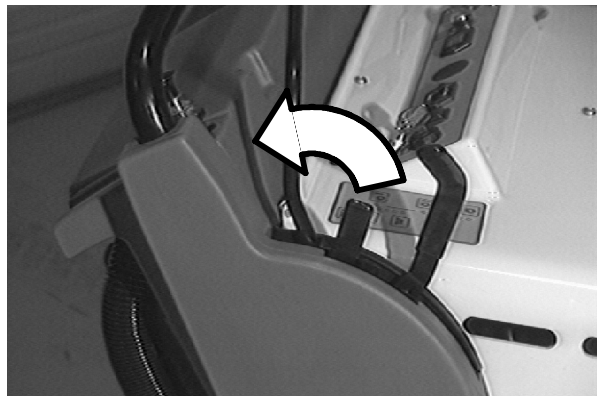

4. Move the directional control lever into the PARK position.

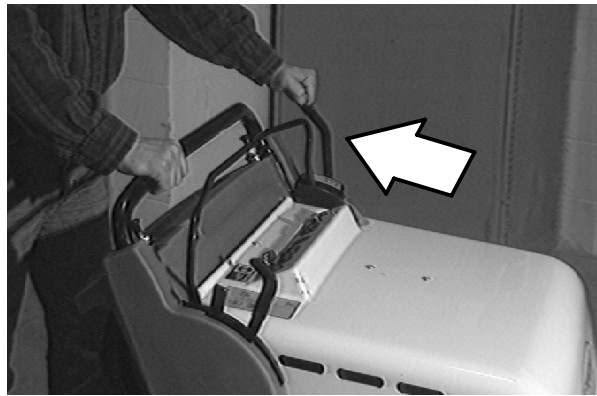

5. Shake the panel filter by pressing the filter shaker switch. The shaker motor will operate for 15 seconds before stopping.

*NOTE: Make sure the filter compartment is closed securely before activating filter shaker.*

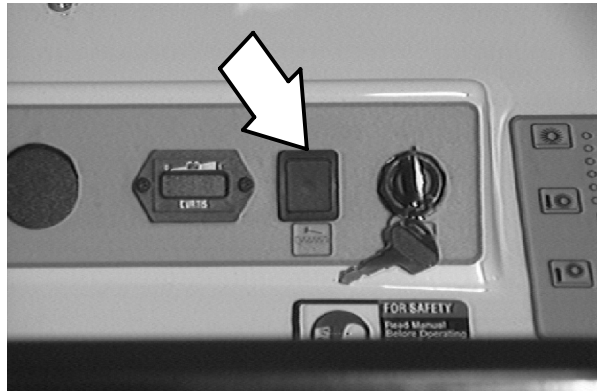

6. Turn the machine power off.



7. LPG powered machines: Ensure the LPG tank service valve is closed.

## EMPTYING THE DEBRIS HOPPER

---

### STANDARD HOPPER

Drive the machine to the area where debris is collected.

Turn the machine power off.

 **WARNING: Brush throws debris. Stop motor before lifting hopper.**

The debris hopper is equipped with one center, and two side finger grips to allow two people to lift and empty the hopper.

Pull the hopper slightly forward to unseat it from the machine frame.



With one person on each side, lift the debris hopper out of the machine.

*NOTE: Do not attempt to lift the hopper when it is full of debris without assistance. Dump the debris from the hopper into a pile on the floor near a trash can or dumpster, then pick the debris up with a shovel.*

 **WARNING: Heavy hopper. Get help to handle.**

**HOPPER DUMP ASSIST HANDLE (OPTION)**

The dump assist handle allows easy removal and transport of the debris hopper when it is full.

Turn the machine power off.

 **WARNING: Brush throws debris. Stop motor before lifting hopper.**

Raise the dump assist handle.



Place one foot on the hopper's pivot point.



Lift the hopper out of the machine and onto the wheels. Transport the hopper to the location where debris is collected.

 **WARNING: Heavy hopper. Get help to handle.**

*NOTE: Do not attempt to lift the hopper when it is full of debris without assistance. Dump the debris from the hopper into a pile on the floor near a trash can or dumpster, then pick the debris up with a shovel.*



## OPERATION

### REPLACING THE BAG FILTER (OPTION)

The bag filter (option) traps dust and small particles of debris. Check the bag filter daily and replace it when it becomes full of debris.

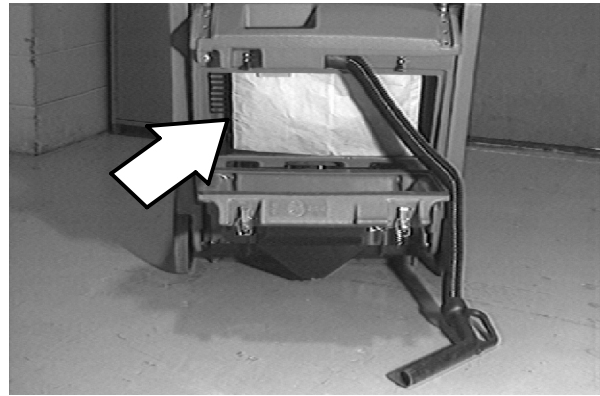

To access the bag filter, remove the vacuum wand and unlatch the filter compartment hooks.

Install a new bag filter by placing the cardboard tab on the filter around the vacuum inlet tube.



The vacuum inlet tube is located at the top of filter compartment, on the inside of the machine.



Latch the filter compartment door. Fully insert the vacuum wand into the machine.

---

**CLEANING THE FILTER COMPARTMENT**

---

The panel filter traps dust and small particles of debris. Press the filter shaker switch to shake the debris from the panel filter each time the hopper is emptied. This debris collects in the filter compartment. Clean the filter compartment daily.

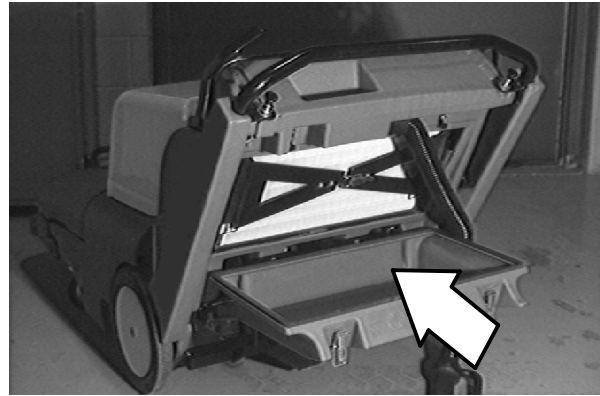

Remove the vacuum wand and unlatch the filter compartment hooks.

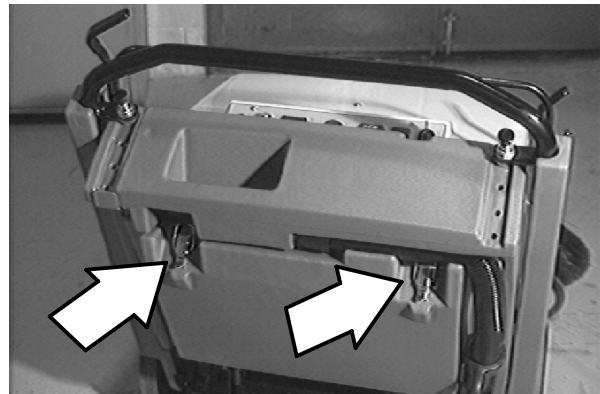

Lower and remove the filter compartment door by sliding it to the left off the pivot pins. Empty the dust and debris.

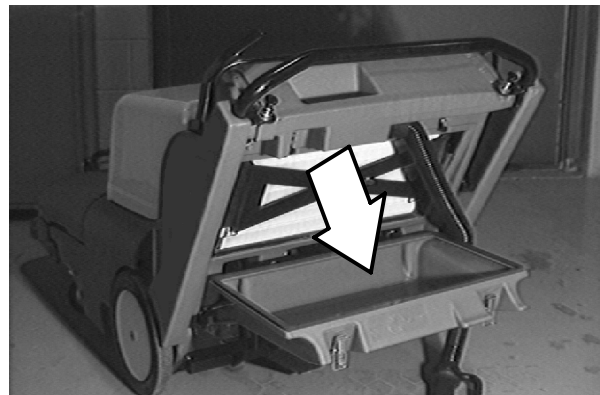

Replace and latch the filter compartment door. Fully insert the vacuum wand into the machine.

## OPERATION

### POST-OPERATION CHECKLIST

Check this list of items after sweeping and emptying hopper:

- Check for wire or string tangled in the bristles of the main brush and side brush(es). Additional side brush option shown.

**FOR SAFETY: Before leaving or servicing machine, stop on level surface, turn off machine, and remove key.**



- Check and, if necessary, wipe the vacuum inlet plate clean.
- LPG powered machines: Ensure the LPG tank service valve is closed.
- Check for fuel odor that indicates a fuel leak.
- Check under the machine for fluid leaks (fuel, oil).
- Check the skirts and seals for damage and wear.
- Check the bag filter (option) for fullness or shake the panel filter and clean the filter compartment.
- Check the service records to determine routine maintenance requirements.



### OPERATION ON INCLINES

When operating the machine on an incline, use first speed for increased power and control. The maximum rated climb and descent angle for the machine is 8°.

**NOTE:** To stop the machine at any time, regardless of direction of travel, release the clutch handle. The machine will immediately slow down, then stop completely.

---

**OPTIONS**

---

**WIDE TRACK TIRES AND HEAVY DUTY CASTERS**

Wide track tires and heavy duty casters provide increased maneuverability and control on rough surfaces.



# OPERATION

## MACHINE TROUBLESHOOTING

Problem	Cause	Remedy
Excessive dusting	Vacuum hose clogged	Unscrew hose from vac wand handle and clean
	Brush skirts and dust seals worn or damaged	Replace brush skirts or dust seals
	Filter bag full or panel filter clogged	Shake and / or clean or replace bag or panel filter
	Vacuum wand hose damaged	Replace vacuum wand hose
	Vacuum wand not fully inserted into machine	Insert fully
	Vacuum inlet plate clogged	Remove / clean plate. Clean chamber if necessary
	Vacuum fan failure	Contact Tennant service personnel
Poor sweeping performance	Brush bristles worn	Replace brushes
	Main brush not touching floor	Check brush linkage for binding or contact Tennant service personnel
	Debris caught in main brush drive mechanism	Remove debris from drive mechanism
	Main brush drive failure	Contact Tennant service personnel
	Side brush drive failure	Contact Tennant service personnel
	Hopper full	Empty hopper
	Hopper / brush skirts worn or damaged	Replace skirts
Machine will not propel or shift	Transmission will not go into gear	Contact Tennant service personnel
	Clutch arm not pulling belt tight enough	Adjust clutch cable length
	Propel belt stop bar not adjusted properly	Contact Tennant service personnel
Machine will not start	Thermo Sentry™ tripped	Reset Thermo Sentry™
	Engine oil level low	Check and fill
	Fuel tank valve closed	Open valve - LPG tank valve or valve below gasoline tank

**MAINTENANCE**

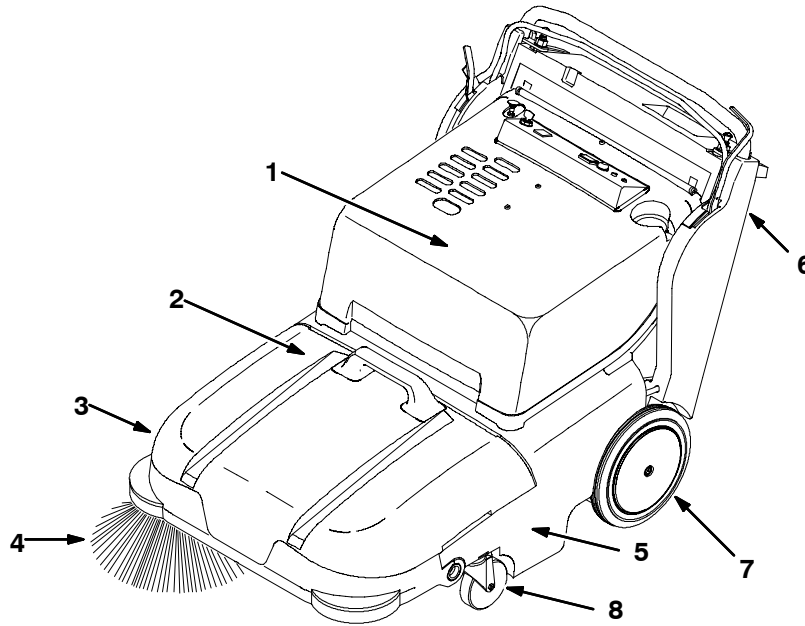

350841

**MAINTENANCE CHART**

Interval	Key	Description	Procedure	Lubricant/ Fluid	No. of Service Points
Daily	1	Engine oil	Check with dipstick	EO	1
	4,5	Main brush and side brush(es)	Check for damage and wear	-	2 (3)
	2	Skirts and seals	Inspect	-	6
	6	Bag filter (option)	Check / replace if full	-	1
	6	Panel filter	Shake filter, clean compartment door	-	1
	2	Vacuum inlet plate	Check / clean	-	1
50 Hours	1	Engine oil	Change	EO	1
	1	Engine air filter	Replace	-	1
	1	Vacuum fan belt	Check tension and wear	-	1
	5	Main brush	Rotate end for end and check brush pattern	-	1
100 Hours	6	Panel filter	Remove and clean	-	1
	7	Wide track tires (option)	Check for damage / pressure	-	2
	8	Heavy duty casters (option)	Lubricate	SPL	2
200 Hours	1	Sparkplug	Check / replace	-	1
	1	Gasoline fuel filter / sediment bowl	Clean	-	1
500 Hours	3	Side brush motor(s)	Check motor brushes	-	1 (2)

**LUBRICANT/FLUID**

EO . . . Engine oil, 30 SAE - CD/SF rated

SPL . . . Special lubricant, Lubriplate EMB grease (TENNANT part no. 01433-1)

## LUBRICATION

---

### ENGINE

Use the dipstick to check the engine oil level daily. Change the engine oil after every 50 hours of operation. Use a straight SAE 30-weight, API class CD / SF or higher engine oil. If multiviscosity oil is used, oil consumption and combustion deposits will increase.

Using oil other than service class SF, or extending oil exchange intervals can cause engine damage not covered by the engine warranty.

The engine oil capacity is 0.65L (1.4 pt).

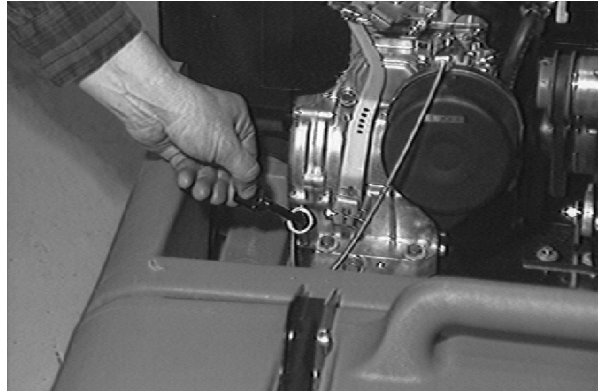

### HEAVY DUTY CASTERS (OPTION)

The heavy duty casters (option) each have one grease fitting on the caster swivel. Lubricate each caster with a grease gun containing Lubriplate EMB grease (Tennant part no. 01433-1) after every 100 hours of operation.

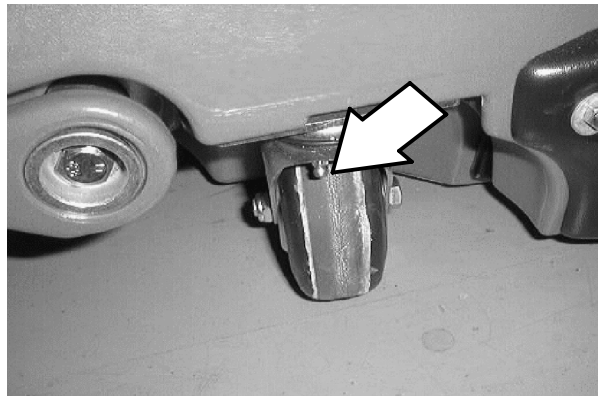

---

**FUEL SYSTEM**

---

**FUEL FILTER AND SEDIMENT BOWL**

Gasoline powered machines are equipped with a fuel filter and a sediment bowl to clean the fuel and collect the debris.

The fuel filter and sediment bowl are located below the gasoline tank. Remove and clean these components every 200 hours of machine use.

**FOR SAFETY: When servicing machine, keep flames and sparks away from fuel system service area. Keep area well ventilated.**

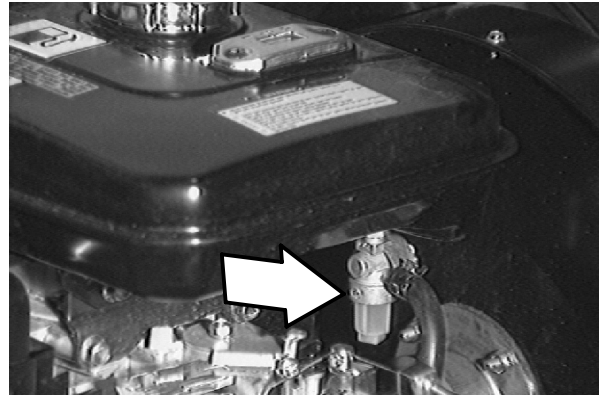

**GAS VALVE**

The gas valve is located on the right-hand side of the fuel filter / sediment bowl assembly. The gas valve shuts off the flow of gas to the engine.

When the valve is closed, the machine will run for a short time, then stop from lack of fuel. Open the valve to start the machine.

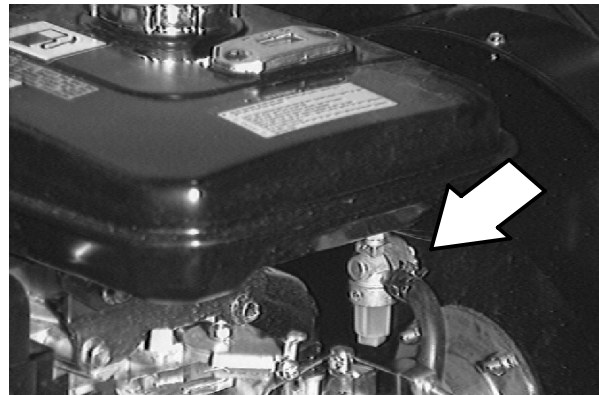

## ENGINE

---

### AIR FILTER

Unlatch the clamp on the side of the filter assembly to remove the air filter. Replace the air filter after every 50 hours of operation.

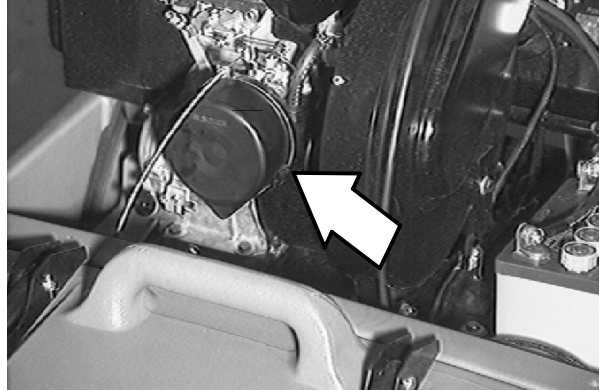

### SPARKPLUG

Replace, or clean and set the gap of the sparkplug after every 200 hours of use.

The proper sparkplug gap is 0.75 mm (0.03 in).

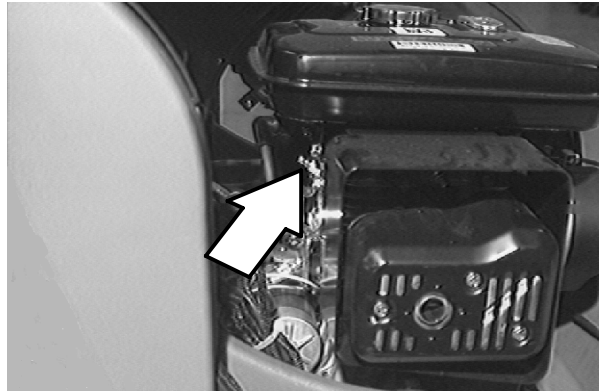

---

**SKIRTS AND SEALS**

---

**MAIN BRUSH SKIRTS**

The main brush skirts are located at the ends of the main brush. These skirts are designed to deflect debris into the hopper.

Check the brush skirts for damage or wear daily.

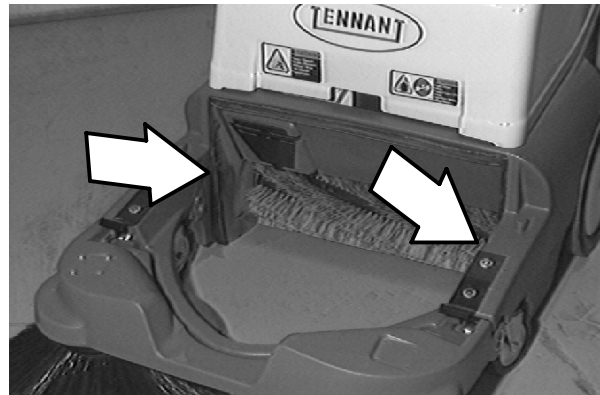
**HOPPER DUST SEAL**

The hopper dust seal, located at the top of the hopper compartment, helps maintain a vacuum within the hopper.

Check the hopper dust seal for damage or wear daily.

**REAR SKIRT**

The rear skirt, located behind the main brush, helps create a vacuum around the main brush.

Check the rear skirt for damage or wear daily.

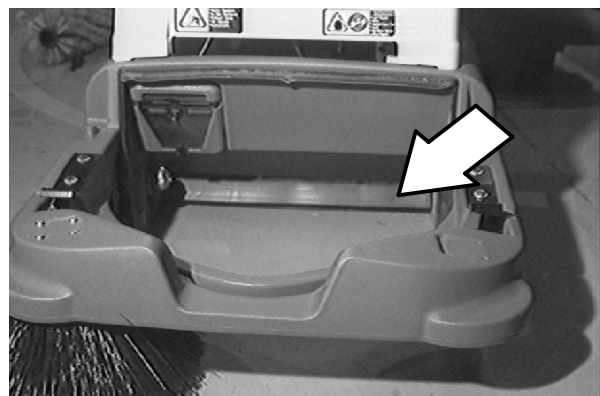

## MAINTENANCE

### HOPPER LIP SKIRT

The hopper lip skirt, located on the lip of the hopper, ensures debris thrown from the main brush will go into the hopper.

Check the hopper lip skirt for damage or wear daily.

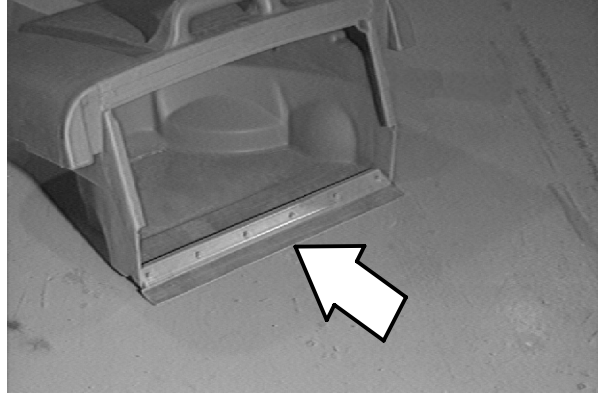

### FILTER COMPARTMENT DOOR SEAL

The filter door seal, located around the perimeter of the filter compartment door, helps maintain a vacuum around the filter.

Check the filter compartment door seal for damage or wear daily.

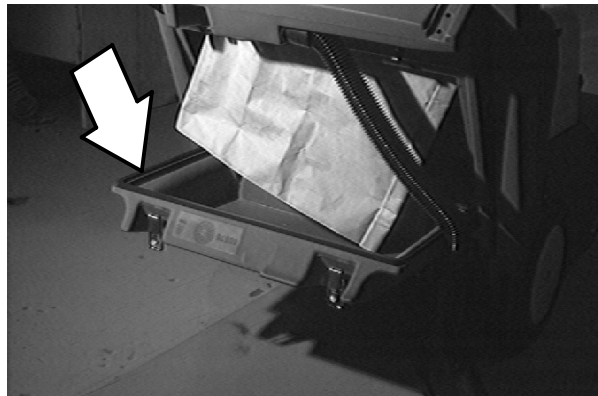

---

### VACUUM INLET PLATE

---

The vacuum inlet plate is located on the left-hand side of the hopper compartment. The vacuum inlet plate prevents large pieces of debris from entering the vacuum chamber.

Check the vacuum inlet plate daily. If necessary remove and wipe it clean with a damp cloth.



---

## CLEANING THE PANEL FILTER

---

The panel filter filters the air pulled up from the hopper. The panel filter is equipped with a shaker to remove the accumulated dust particles. Remove and thoroughly clean the panel filter after every 100 hours of use.

To remove the panel filter, unlatch and lower the filter compartment door.

Unlatch the panel filter retainer and remove the filter.

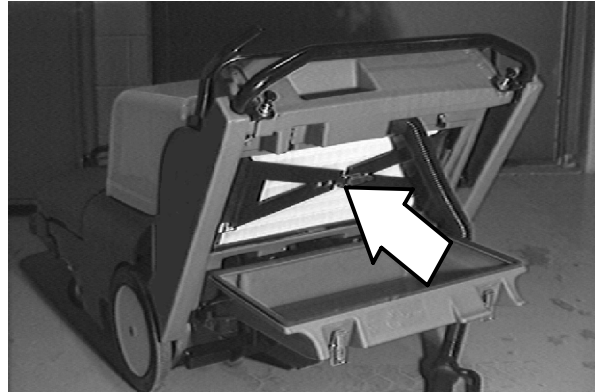

To clean the panel filter, use one of the following methods:

- **TAPPING** - Tap the filter gently on a flat surface with the dirty side down. Do not damage the edges of the filter element, or the filter will not seat properly in the filter compartment.
- **AIR** - Blow air through the filter from the opposite side of the fingertabs. Always wear eye protection when using compressed air.

**FOR SAFETY: When servicing machine, wear eye and ear protection if using pressurized air or water.**

## BRUSHES

---

### MAIN BRUSH

The main brush spans the width of the machine and throws debris into the hopper.

Check the brush for damage and wear daily. Remove string or wire tangled in the main brush or the main brush hub.

Check the main brush pattern after every 50 hours of use. Adjust the main brush pattern by loosening the nut at the left end of the brush arm crossbar.

Rotate the main brush after every 50 hours of use for maximum brush life and sweeping performance.

Replace main brush when bristle length is 9 to 12 mm (.375 to .5 in).

### REPLACING THE MAIN BRUSH

1. Turn the machine power off and move the directional lever into the PARK position.

**FOR SAFETY: Before leaving or servicing machine, stop on level surface, turn off machine, and remove key.**

2. The main brush pin, located on the left-hand side of the machine, holds the main brush in place. Turn the main brush pin 1/4 turn counter-clockwise and remove. If the machine has the (option) wide track wheel kit, lower the main brush to remove.



3. Remove the debris hopper.
4. Pull the string guard and skirt back to avoid damaging.



5. Pull the main brush out of the machine through the hopper opening.

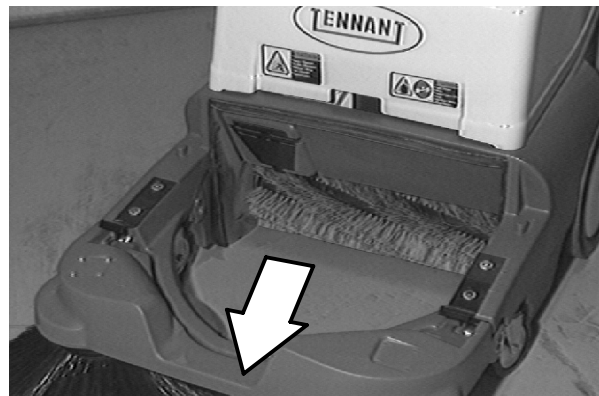

6. Remove the brush hub from the worn brush and install it into the new brush.

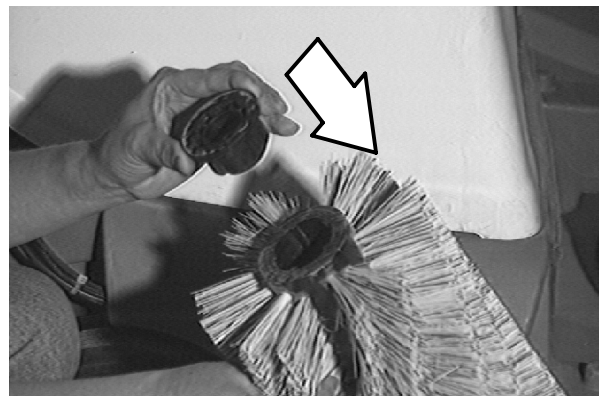

7. Install the new main brush into the machine.
8. Insert the main brush pin through the hole in the frame and into the main brush hub. Turn the main brush pin 1/4 turn clockwise.
9. Replace the hopper.

## MAINTENANCE

### CHECKING AND ADJUSTING MAIN BRUSH PATTERN

1. Apply chalk (or another material that will not easily blow away), to a smooth, level section of the floor.
2. Lower the main brush in the chalked area. Allow the machine to sweep in the same place for 15 to 20 seconds.

*NOTE: If chalk or other material is not available, allow the brush to spin on the floor for two minutes. A polish mark will remain on the floor.*

3. Raise the main brush and move the machine away from the chalked area. Turn the machine power off.
4. Observe the shape of the brush pattern. If the brush pattern has parallel sides, the brush does not need adjustment.

If the brush pattern is tapered, the main brush needs adjustment to straighten the brush pattern.

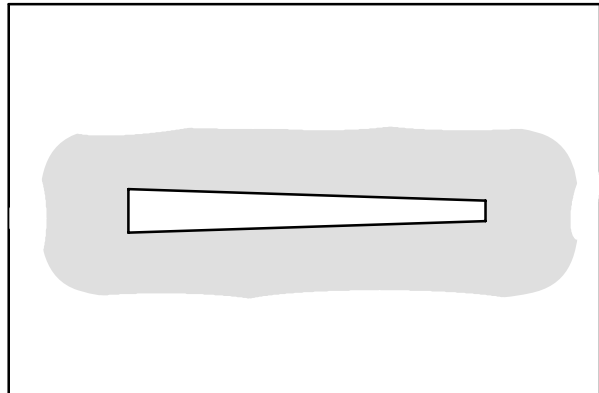

- A. To adjust brush taper, loosen the nut at the left end of the brush arm crossbar. Move the crossbar up or down in the slide relative to the adjustment on the other side. Tighten the nut.
- B. Check the brush again pattern and readjust if necessary.



**ROTATING THE MAIN BRUSH**

1. Turn the machine power off and move the directional lever into the PARK position.

**FOR SAFETY: Before leaving or servicing machine, stop on level surface, turn off machine, and remove key.**

2. Turn the main brush pin 1/4 turn counter-clockwise and remove.
3. Remove the debris hopper.
4. Pull the main brush out of the machine through the hopper opening.
5. Remove the brush hub from the main brush and install it into the other end.
6. Install the main brush into the machine.
7. Insert the main brush pin through the hole in the frame and into the main brush hub. Turn the main brush pin 1/4 turn clockwise.



8. Replace the hopper.

## MAINTENANCE

---

### SIDE BRUSH(ES)

The side brush(es) sweep debris along walls and edges into the path of the main brush.

Check the side brush(es) for damage and wear daily. Remove string or wire tangled in the side brush(es).

A side brush should be replaced when it no longer effectively sweeps for your application.

### REPLACING THE SIDE BRUSH(ES)

1. Turn the machine power off and move the directional lever into the PARK position.

**FOR SAFETY: Before leaving or servicing machine, stop on level surface, turn off machine, and remove key.**

2. Reach underneath the side brush and remove the cotter pin that holds it on the drive shaft.

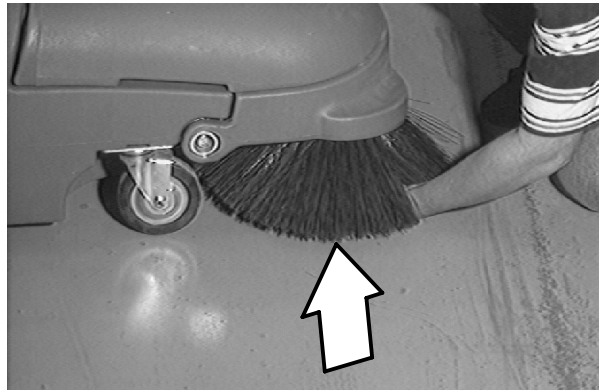

3. Remove the worn brush.
4. Place a new side brush onto the drive shaft and secure with the cotter pin.

---

### ELECTRIC MOTORS

---

Check the side brush motor(s) brushes every 500 hours of operation. Replace the motor brushes when they are worn 9 mm (.375 in).

---

**BELTS AND CHAINS**

---

**VACUUM FAN BELT**

The vacuum fan belt drives the vacuum system. Check the belt for wear and tension after every 50 hours of operation.

Check belt tension by applying a force 1 kg (2 lb) at belt midpoint. The proper deflection should be 5 mm (0.09 in).

 **WARNING: Moving belt and fan. Keep away.**

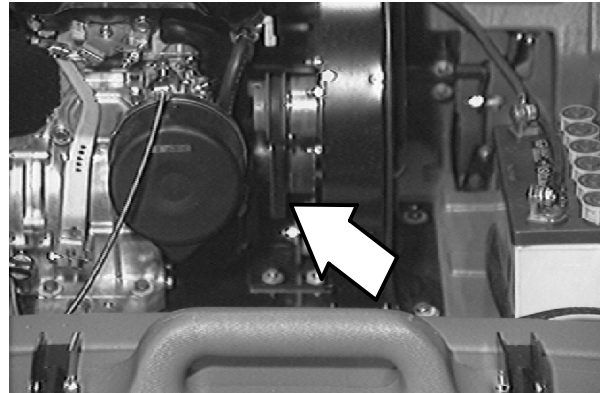

**MAIN BRUSH BELT**

The main brush drive belt is located behind the right rear tire. The belt drives the main brush. The proper belt tension is automatically set by a spring-loaded idler.

**STATIC DRAG CHAIN**

The static drag chain prevents the buildup of static electricity in the machine. The chain is attached to the backstop bracket.

Make sure the chain is always touching the floor.

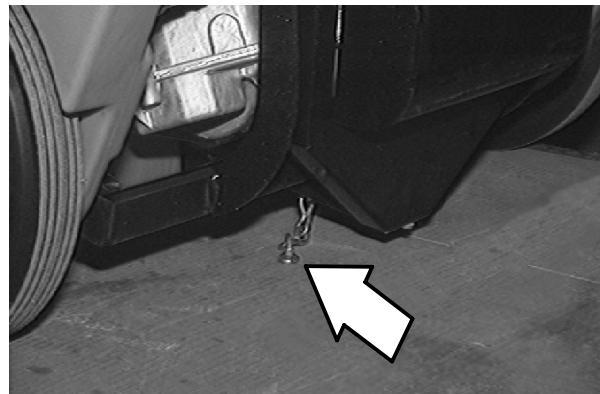



---

**CLUTCH CABLE**

---

The clutch handle engages the machine's propelling system. The clutch handle is connected to the clutch cable. The clutch cable may stretch over time and require adjustment.

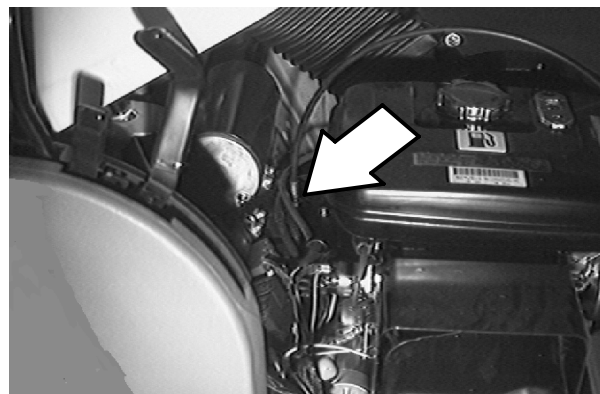
Adjust cable length by turning the nut at the base of the clutch cable.



---

### TIRES (OPTION)

---

The optional heavy duty rear tires are pneumatic.

Check the rear tires after every 100 hours of operation for damage. Check the rear tire pressure after every 100 hours of operation. The proper tire pressure is 345 kPa (50 psi).

**PUSHING AND TRANSPORTING THE MACHINE**

**PUSHING THE MACHINE**

If the machine becomes disabled, it can be easily pushed in neutral if necessary.

**TRANSPORTING THE MACHINE**

1. Position the front of the machine at the loading edge of the truck or trailer.

**FOR SAFETY: Use truck or trailer that will support the weight of the machine.**

*NOTE: Empty the hopper before transporting the machine.*

2. If the loading surface is not horizontal or is higher than 380 mm (15 in) from the ground, use a winch to load machine.

If the loading surface is horizontal AND is 380 mm (15 in) or less from the ground, the machine may be pushed onto the truck or trailer.

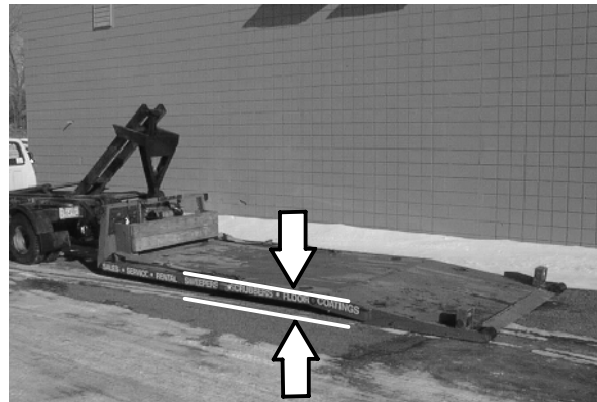

3. To winch the machine onto the truck or trailer, remove the hopper and place a strap through the front frame of the machine. Make sure the machine is in neutral and is centered.

**FOR SAFETY: When loading machine onto truck or trailer, use winch. Do not push the machine onto the truck or trailer unless the loading surface is horizontal AND is 380 mm (15 in) or less from the ground.**



4. Position the machine onto the truck or trailer as far as possible. If the machine starts to veer off the centerline of the truck or trailer, stop and center the machine.

## MAINTENANCE

5. Block the machine tires and place the directional control lever in Park. Tie down the machine to the truck or trailer before transporting.

Secure the rear of the machine by wrapping straps around each end of the the handle and fastening them to the truck or trailer.



Secure the front of the machine by wrapping a strap around the hopper and fastening it to the truck or trailer.



6. If the loading surface is not horizontal or is higher than 380 mm (15 in) from the ground, use a winch to unload machine.

If the loading surface is horizontal AND is 380 mm (15 in) or less from the ground, the machine may be pushed off the truck or trailer.

**FOR SAFETY: When unloading machine off truck or trailer, use winch. Do not push the machine off the truck or trailer unless the loading surface is horizontal AND 380 mm (15 in) or less from the ground.**

---

**STORING MACHINE**

---

When storing the machine for extended periods of time, the following procedures must be followed:

1. Raise the main and side brush(es).
2. Empty and clean the debris hopper.
3. Drain or disconnect and remove (LPG tank) fuel system.
4. Close the gasoline valve.
5. Change the engine oil.
6. Remove the spark plug, pour 30 cc (1 oz) of engine oil into the cylinder. Slowly rotate the crankshaft to distribute the oil. Replace the spark plug.
7. Clean the engine cooling fins.
8. Store the machine in a clean dry area.

# SPECIFICATIONS

## SPECIFICATIONS

### GENERAL MACHINE DIMENSIONS/CAPACITIES

Item	Dimension/capacity
Length (Low / High steering bar position)	1428 / 1475 mm (56.25 / 58 in)
Width	820 mm (32.25 in)
Width (Wide track wheel kit option)	933 mm (36.75 in)
Height (Low / High steering bar position)	880 / 960 mm (34.7 / 37.7 in)
GVWR - Gasoline engine	206 kg (455 lb)
GVWR - LPG engine	220 kg (485 lb)
Track	775 mm (30.50 in)
Wheelbase	490 mm (19.36 in)
Main brush diameter	205 mm (8 in)
Main brush length	610 mm (24 in)
Side brush diameter	420 mm (16.5 in)
Sweeping path width, main brush only	610 mm (24 in)
Sweeping path width, main brush and one side brush	815 mm (32 in)
Sweeping path width, main brush and two side brushes	1015 mm (40 in)
Hopper capacity - Maximum	85 L (3.0 cu ft)
Hopper capacity - Usable	42.5 L (1.5 cu ft)
Panel filter area	3.62 sq m (39 sq ft)
Bag filter volume	17 L (0.6 cu ft)

### GENERAL MACHINE PERFORMANCE

Item	Measure
Maximum forward speed - first speed	1.5 kmh (0.9 mph)
Maximum forward speed - second speed	2.7 kmh (1.7 mph)
Maximum forward speed - third speed	5.0 kmh (3.1 mph)
Maximum reverse speed	2.2 kmh (1.4 mph)
Minimum steering diameter	1588 mm (62.5 in)
Minimum turning radius	794 mm (31.25 in)
Maximum rated climb and descent angle	8°
Fuel consumption - Gasoline engine	0.75 L/hr (0.2 gal/hr)
Fuel consumption - LPG engine	0.4 kg/hr (0.9 lb/hr)

**POWER TYPE**

Engine	Type	Ignition	Cycle	Aspiration	Cylinders	Bore	Stroke	
	OHV	Gas - magneto	4	Natural	1	67 mm (2.14 in)	49 mm (1.93 in)	
		LPG - Solid State						
	Displacement		Net power, governed		Net power, maximum			
	172 cc (10.5 cu in)		3.6 hp @ 2400 rpm		6 hp @ 4000 rpm			
	Fuel		Cooling system		Electrical system			
	Automotive regular gasoline, 87 octane minimum, unleaded. Fuel tank: 3.6L (0.95 gal)		Air		Alternator output 13.5 V / 9.6A @ 2400 rpm			
	LPG, (vapor) Fuel tank: 9 kg (20 lb)				12 V Battery- 260 cca			
	Governed speed, under load							
	2400 rpm maximum							
	Engine lubricating oil with filter							
	0.65L (1.4 pt) 30 SAE-CD/SF rated engine oil							

**ELECTRIC MOTORS**

Type	Use	VDC / Amp	Kw (hp)
Electric Motors	Side brush(es) (disk)	13 V / 4.25 A	0.075 (.1)

**TIRES**

Location	Type	Size
Front (2)	Casters	35 mm wide x 127 mm OD (1.375 in wide x 5 in OD)
Rear (2)	Solid	45 mm wide x 305 mm OD (1.75 in wide x 12 in OD)

# SPECIFICATIONS

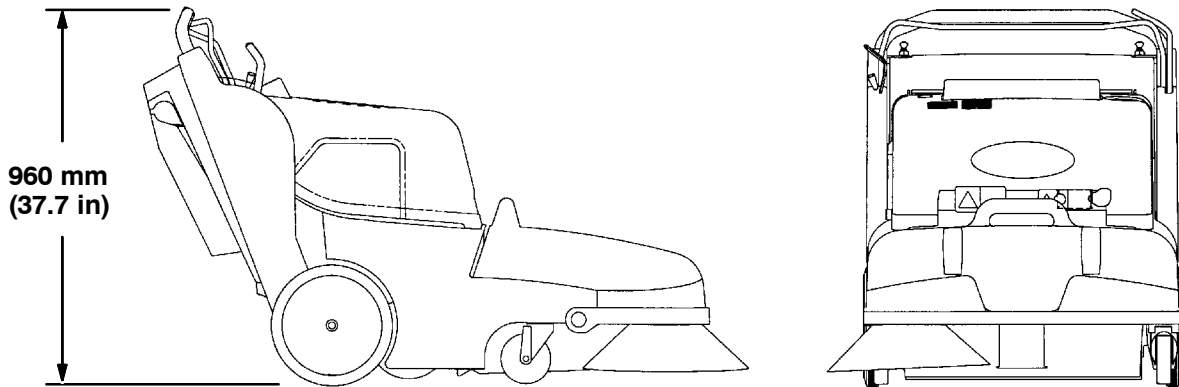
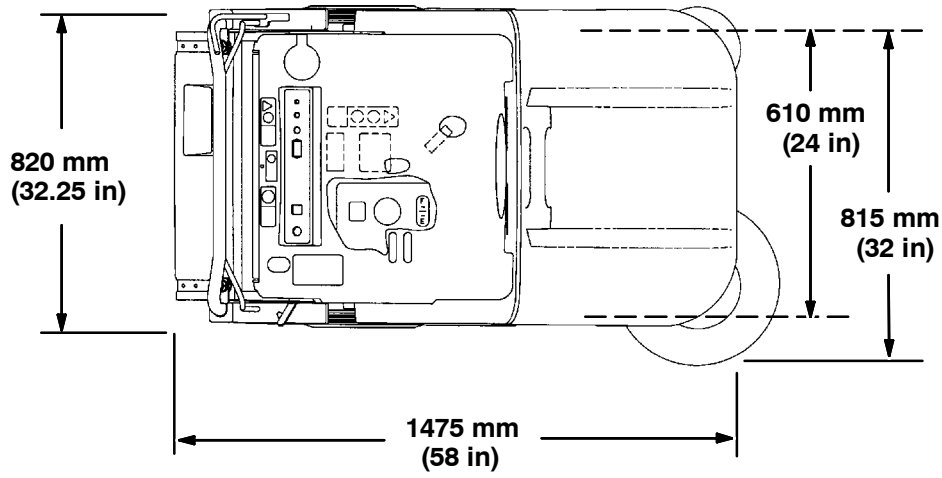

## MACHINE DIMENSIONS

350910

## INDEX

**B**

Bag filter replacement, 28  
 Battery, low charge indicator, 14  
 Belts  
   Main brush, 45  
   Vacuum fan, 45  
 Braking, stopping machine, 12  
 Brush information, 22  
 Brushes  
   Main brush, 40  
   Main brush pattern, checking, adjusting, 42  
   Main brush, rotation, 43  
   Replacing main brush, 40  
   Replacing side brush(es), 44  
   Side brush(es), 44

**C**

Cable, clutch, 45  
 Chain, static drag, 45  
 Choke, engine, 13  
 Circuit breaker, 16  
 Clutch cable, 45  
 Clutch handle, 12  
 Controls  
   Clutch handle, 12  
   Directional control lever, 10  
   Engine choke knob, 13  
   Ignition key switch, 15  
   Main brush lever, 12  
   Side brush lever, 13  
   Steering bar, 14  
   Steering bar adjustment knobs, 14  
 Controls and Instruments, 9

**D**

Directional control lever, 10

**E**

Electric motors, 44  
 Electrical system, Circuit breaker, 16  
 Engine  
   Air filter, 36  
   Sparkplug, 36

Specifications, 51

**F**

Filter compartment, Cleaning panel filter compartment, 29  
 Filter shaker switch (option), 16  
 Filters  
   Air filter (engine), 36  
   Bag filter replacement, 28  
   Panel filter cleaning, 39  
 Fuel system  
   Fuel filter, 35  
   Gas valve, 35  
   Sediment bowl, 35  
 Fuel tank - LPG, Changing LPG fuel tank, 19

**H**

Hopper  
   Dump assist handle emptying (option), 27  
   Standard hopper emptying, 26  
 Hourmeter, 15

**I**

Indicators  
   Low battery charge indicator, 14  
   Low oil warning indicator, 13  
 Instruments  
   Hourmeter, 15  
   Low battery charge indicator, 14  
   Low oil warning indicator, 13

**K**

Key, ignition switch, 15

**L**

Levers  
   Directional control lever, 10  
   Main brush lever, 12  
   Side brush lever, 13  
 LPG fuel tank, changing, 19  
 Lubrication  
   engine, 34  
   heavy duty casters (option), 34

**M**

Machine, Storage, 49  
Machine components, 7  
Machine dimensions, 52  
Machine troubleshooting, 32  
Main brush, 40  
    Checking and adjusting brush pattern, 42  
    Replacement, 40  
    Rotation, 43  
Main brush lever, 12  
Maintenance, Recommended, 6  
Maintenance chart, 33  
Motors, electric, 44

**O**

Oil, low warning indicator, 13  
Operation  
    Changing an LPG fuel tank, 19  
    How the machine works, 17  
    Post-operation checklist, 30  
    Pre-operation checklist, 17  
    Starting the machine, 21  
    Stop sweeping, 24  
    Stopping the machine, 12  
    Sweeping, 23  
    Sweeping and brush information, 22  
    Sweeping on inclines, 30  
Operation of controls, 10  
Operator responsibility, 5  
Options  
    Filter shaker switch, 16  
    Hopper dump assist handle, 27  
    Panel filter, 39  
    Wide track tires and casters, 31

**P**

Panel filter, Cleaning, 39  
Panel filter compartment, Cleaning, 29  
Plate, vacuum inlet, 38  
Pushing and transporting machine, 47  
Pushing machine, 47  
Pushing the machine, 47

**S**

Safety  
    Labels, 4  
    Precautions, 3  
Side brush lever, 13  
Side brush(es) replacement, 44  
Skirts and seals  
    Filter compartment door seal, 38  
    Hopper dust seal, 37  
    Hopper lip skirt, 38  
    Main brush skirts, 37  
    Rear skirt, 37  
Sparkplug, 36  
Specifications  
    Climb and descent angles, maximum, 50  
    Electric motors, 51  
    Engine, 51  
    Fuel consumption, 50  
    Machine capacities, 50  
    Machine dimensions, 50  
    Machine performance, 50  
    Tires, 51  
    Traveling speeds, 50  
    Turning radius, 50  
Steering bar, 14  
Steering bar adjustment knobs, 14  
Storing machine, 49  
Sweeping, 23  
Sweeping and brush information, 22  
Switches  
    Filter shaker switch (option), 16  
    Ignition key switch, 15  
Symbols, definitions, 8

**T**

Thermo Sentry, 16  
Tires, 46  
    Specifications, 51  
Transporting machine, 47  
Transporting the machine, 47  
Troubleshooting chart, 32

**V**

Vacuum inlet plate, 38  
Vacuum wand, 15