

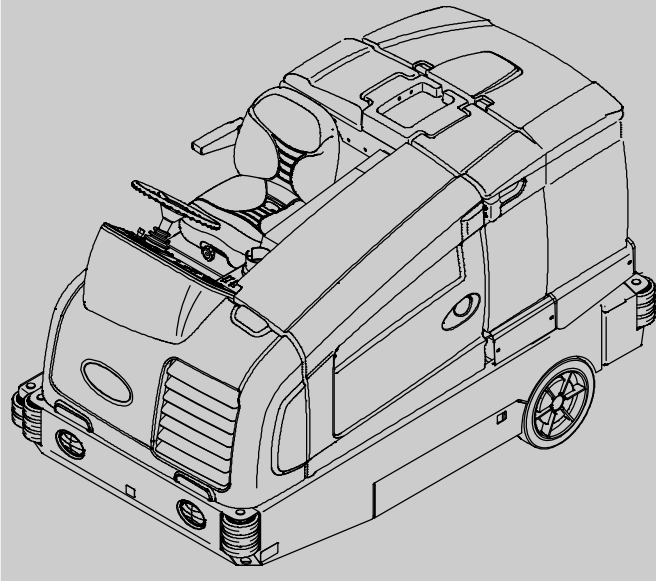

# T20

(Diesel)

(SN/ 008000- )  
Rider Scrubber  
English **EN**  
Operator Manual

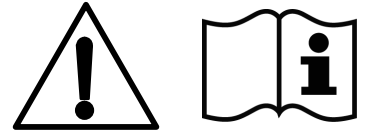

**The Safe Scrubbing Alternative<sup>®</sup>**

**ES<sup>®</sup> Extended Scrub System**

**Tennant True<sup>®</sup> Parts**

**Hygenic<sup>®</sup> Fully Cleanable Tanks**

**FloorSmart<sup>®</sup> Integrated Cleaning System**

**IRIS<sup>®</sup> a Tennant Technology**

**Pro-Panel<sup>™</sup> Controls**

**Insta-Fit<sup>™</sup> Adapter**



## North America / International



For the latest Parts manuals and other  
language Operator manuals, visit:

[www.tennantco.com/manuals](http://www.tennantco.com/manuals)

9016250  
Rev. 03 (8-2022)



## INTRODUCTION

This manual is furnished with each new model. It provides necessary operation and maintenance instructions.



**Read this manual completely and understand the machine before operating or servicing it.**

This machine will provide excellent service. However, the best results will be obtained at minimum costs if:

- The machine is operated with reasonable care.
- The machine is maintained regularly - per the machine maintenance instructions provided.
- The machine is maintained with manufacturer supplied or equivalent parts.

PROTECT THE ENVIRONMENT	MACHINE DATA
	Please fill out at time of installation for future reference.
Please dispose of packaging materials, used components such as batteries and fluids in an environmentally safe way according to local waste disposal regulations.	Model No. – _____
	Serial No. – _____
Always remember to recycle.	Installation Date – _____

## INTENDED USE

The T20 is an industrial rider machine designed to scrub hard surfaces (concrete, asphalt, stone, synthetic, etc). Typical applications include industrial warehouses, manufacturing facilities, distribution facilities, stadiums, arenas, convention centers, parking facilities, transportation terminals, and construction sites. Do not use this machine on soil, grass, artificial turf, or carpeted surfaces. Do not use where excessive debris is present such as leaves, paper, etc. This machine can be used both indoors and outdoors, but ensure there is adequate ventilation if used indoors. This machine is not intended for use on public roadways. Do not use this machine other than described in this Operator Manual.

### Tennant Company

10400 Clean Street  
Eden Prairie, MN 55344-2650  
Phone: (800) 553-8033  
www.tennantco.com



### CALIFORNIA PROPOSITION 65 WARNING:

**Engine exhaust from this product contains chemicals known to the State of California to cause cancer, birth defects, or other reproductive harm.**

PerformanceView, Pro-ID, Pro-Check, Zone Settings, Thermo-Sentry, Touch-N-Go, 1-STEP, Clean-Wedge, Variable Drain Valve, EasyOpen, Grip-n-Go, MaxPro, Dura-Track, SmartRelease, InstantAccess, Duramer, FaST-PAK, ErgoSpace, and Lower Total Cost of Ownership are trademarks of Tennant Company.

Specifications and parts are subject to change without notice.

Original Instructions, copyright © 2016, 2017, 2020, 2022 TENNANT Company, Printed in U.S.A.

**CONTENTS**

	Page		Page
Important Safety Instructions .....	4	Filling The Solution Tank .....	35
Operation .....	8	Foam Scrubbing (Fast Mode) / Ec-H2o	
Machine Components .....	8	Scrubbing (Ec-H2o Mode) .....	35
Controls And Instruments .....	9	Conventional Scrubbing Mode .....	35
Standard Touch Panel .....	10	Es (Extended Scrub) Mode	
Pro-Panel Controls .....	11	With Auto-Fill .....	36
Symbol Definitions .....	12	Es (Extended Scrub) Mode -	
Operation Of Controls - Standard Panel ..	15	Manually Filling Tank .....	36
Fuel Indicator .....	15	Setting Scrub Modes .....	37
Hour Meter .....	15	Setting Ec-H2o Mode .....	37
Recovery Tank Full Indicator .....	15	Setting Fast Mode .....	38
Solution Tank Indicator .....	15	Setting Es (Extended Scrub) Mode ....	38
Contrast Control Button .....	15	Setting Brush Pressure .....	39
Engine Speed Button .....	16	Setting Brush Pressure -	
1-Step Button .....	16	Standard Panel .....	39
Scrubbing Side Brush Button (Option) .	17	Setting Brush Pressure - Pro-Panel ..	39
Scrubbing Vacuum Fan /		Setting Solution Flow .....	40
Squeegee Button .....	17	Es (Extended Scrub) Solution Flow ...	40
Scrubbing Main Brush Button .....	17	Setting Solution Flow - Standard Panel	40
Solution On / Off Button .....	17	Setting Solution Flow - Pro-Panel ....	40
Operation Of Controls - Pro-Panel .....	18	Scrubbing - Standard Panel .....	41
Pro-Id Login Screen .....	18	Scrubbing - Pro-Panel .....	42
Machine Status Button .....	18	Double Scrubbing .....	43
Changing The Default Button .....	19	Water Pickup Mode (No Scrubbing) .....	44
1-Step Button .....	19	Emptying And Cleaning The Debris Tray -	
Scrubbing Main Brush Button .....	20	Cylindrical Scrub Heads Only .....	45
Scrubbing Vacuum Fan /		Draining And Cleaning The Recovery Tank	47
Squeegee Button .....	20	Draining The Recovery Tank With	
Scrubbing Side Brush Button (Option) .	20	The Drain Hose .....	47
Solution On / Off Buttons .....	20	Draining The Recovery Tank With	
Engine Speed Button .....	21	The Drain Plug .....	48
Zone Control Buttons .....	21	Draining And Cleaning The Solution Tank .	50
Rearview Camera Button .....	22	Faults / Alerts .....	52
Help Button .....	23	Fault / Alert Indicators - Standard Panel	52
Video Help Button .....	25	Fault / Alert Indicators - Pro-Panel ...	52
Completing The Pro-Check		Options .....	54
Pre-Operation Checklist .....	26	Spray Nozzle (Option) .....	54
Operation Of Controls - All Machines ....	27	Detergent Metering (Option) .....	55
Operating Lights .....	27	Vacuum Wand (Option) .....	56
Hazard Light (Option) .....	27	Power Wand (Option) .....	57
Glow Plug Light (Preheat) .....	27	High Pressure Washer (Option) .....	59
Operator Seat .....	28	Machine Troubleshooting .....	61
Seat Belts .....	28	Maintenance .....	63
Steering Column Tilt Knob .....	28	Maintenance Chart .....	64
Brake Pedal .....	29	Yellow Touch Points .....	67
Parking Brake Pedal .....	29	Lubrication .....	67
Directional Pedal .....	29	Engine Oil .....	67
Squeegee Protectors (Option) .....	29	Squeegee Caster Bearings .....	67
How The Machine Works .....	30	Front Wheel Support Bearing .....	67
Brush And Pad Information .....	31	Steering Cylinder Bearing .....	67
While Operating The Machine .....	32	Rear Wheel Bearings .....	68
Pre-Operation Checklist .....	33	Torque Tubes-Cylindrical Brushes ....	68
Starting The Machine .....	34	Torque Tubes-Disk Brushes .....	68
Turning Off The Machine .....	34	Pivot Shaft-Disk Brushes .....	68

# CONTENTS

	Page		Page
Hydraulics .....	69	Skirts And Seals .....	95
Hydraulic Fluid .....	70	Scrub Head Skirt .....	95
Hydraulic Hoses .....	70	Recovery Tank Seal .....	95
Engine .....	71	Solution Tank Seals .....	95
Cooling System .....	71	Brakes And Tires .....	96
Air Filter .....	72	Brakes .....	96
Fuel Filter .....	72	Tires .....	96
Fuel Lines .....	72	Front Wheel .....	96
Priming The Fuel System .....	73	Propelling Motor .....	96
Engine Belt .....	73	Pushing, Towing, And Transporting	
Battery .....	73	The Machine .....	97
Fuses And Relays .....	74	Pushing Or Towing The Machine .....	97
Relay Panel Fuses And Relays .....	74	Transporting The Machine .....	97
Engine Harness Fuses And Relays .....	75	Machine Jacking .....	99
Optional Relays .....	75	Storage Information .....	99
Circuit Breakers (Ec-H2o) .....	75	Freeze Protection (Machines Without	
Scrub Brushes And Pads .....	75	Ec-H2o System) .....	100
Disk Brushes .....	75	Freeze Protection (Machines With	
Replacing Disk Brushes Or		Ec-H2o System)	
Pad Driver .....	76	(S/N 000000-013000) .....	101
Replacing Disk Pads .....	77	Freeze Protection (Machines With	
Checking The Disk Scrub Head		Ec-H2o System)	
Stop Bumpers .....	77	(S/N 013001-	
Cylindrical Brushes .....	78	) .....	103
Replacing Or Rotating Cylindrical		Freeze Protection (Machines With	
Brushes .....	78	High Pressure Washer Option) ...	104
Checking Cylindrical Brush Pattern .	79	Preparing The Machine For Operation	
Adjusting The Cylindrical		After Storage .....	105
Brush Taper .....	80	Priming The Ec-H2o System	
Adjusting The Cylindrical Brush		(Machines S/N 000000-013000) ..	106
Width .....	80	Specifications .....	107
Side Brush (Option) .....	81	General Machine Dimensions/Capacities	107
Replacing The Side Brush .....	81	General Machine Performance .....	107
Fast System .....	82	Hydraulic System .....	108
Replacing The Fast-Pak Carton .....	82	Braking System .....	108
Cleaning The Fast Supply Hose		Tires .....	108
Connector .....	83	Steering .....	108
Cleaning The Fast System Filter Screen	83	Conventional Scrubbing .....	109
Replacing The Fast System Filters .....	83	Ec-H2o System .....	109
Ec-H2o Module Flush Procedure .....	84	Fast System .....	109
Ec-H2o Module Flush Procedures		Detergent Metering System .....	110
(S/N 000000-013000) .....	84	Machine Dimensions .....	110
Ec-H2o Module Flush Procedures		Supervisor Controls .....	111
(S/N 013001-		Pro-Panel Supervisor Controls .....	111
) .....	86	Entering The Supervisor Mode -	
Cleaning The Ec-H2o Filter Screen		First Time Use Only .....	111
(S/N 000000-013000) .....	87	Entering The Supervisor Mode .....	112
Squeegee Blades .....	88	Supervisor Setting Screen /	
Replacing (Or Rotating) The Rear		Screen Icons .....	113
Squeegee Blades .....	88	Adding / Editing Profiles .....	114
Replacing Or Rotating The Side		Enabling The Login .....	116
Squeegee Blades .....	90	Disabling The Login .....	117
Replacing Or Adjusting The Side Brush		Calibrating The Touch .....	117
Squeegee Blade (Option) .....	92	Exporting Checklists .....	118
Leveling The Rear Squeegee .....	93	Checklist Setup .....	119
Adjusting The Rear Squeegee Blade		Disabling / Enabling The Pre-Operation	
Deflection .....	94	Checklist .....	120
		Changing The Rear View	
		Camera Settings .....	121

	Page
Programming The Zone Control	
Buttons .....	121
Setting / Changing The Date And Time	123

# SAFETY PRECAUTIONS

## IMPORTANT SAFETY INSTRUCTIONS – SAVE THESE INSTRUCTIONS

The following precautions are used throughout this manual as indicated in their description:

 **WARNING:** To warn of hazards or unsafe practices that could result in severe personal injury or death.

 **CAUTION:** To warn of unsafe practices that could result in minor or moderate personal injury.

**FOR SAFETY:** To identify actions that must be followed for safe operation of equipment.

The following information signals potentially dangerous conditions to the operator. Know when these conditions can exist. Locate all safety devices on the machine. Report machine damage or faulty operation immediately.

 **WARNING:** Flammable materials can cause an explosion or fire. Do not use flammable materials in tank.

 **WARNING:** Flammable materials or reactive metals can cause an explosion or fire. Do not pickup.

 **WARNING:** Moving belt and fan. Keep away.

 **WARNING:** Engine emits toxic gases. Serious injury or death can result. Provide adequate ventilation.

 **WARNING:** Burn hazard. Hot surface. Do NOT touch.

 **WARNING:** Do not spray people or animals. Severe personal injury can result. Wear eye protection. Hold sprayer with two hands.

This machine may be equipped with technology that automatically communicates over the cellular network. If this machine will be operated where cell phone use is restricted because of concerns related to equipment interference, please contact a Tennant representative for information on how to disable the cellular communication functionality.

**FOR SAFETY:**

1. Do not operate machine:
  - Unless trained and authorized.
  - Unless operator manual is read and understood.
  - Under the influence of alcohol or drugs.
  - While using a cell phone or other types of electronic devices.
  - In dusty environments without the vacuum fan on.
  - Without filters in place or with clogged filters.
  - Unless mentally and physically capable of following machine instructions.
  - If it is not in proper operating condition.
  - With pads or accessories not supplied or approved by Tennant. The use of other pads may impair safety.
  - In areas where flammable vapors/liquids or combustible dusts are present.
  - In areas that are too dark to safely see the controls or operate the machine unless operating / headlights are turned on.
  - In areas with possible falling objects unless equipped with overhead guard.
2. Before starting machine:
  - Check for fuel, oil, and liquid leaks.
  - Keep sparks and open flame away from refueling area.
  - Make sure all safety devices are in place and operate properly.
  - Check brakes and steering for proper operation.
  - Adjust seat and fasten seat belt.
3. When starting machine:
  - Keep foot on brake and directional pedal in neutral.

### 4. When using machine:

- Use only as described in this manual.
- Use brakes to stop machine.
- Do not pick up burning or smoking debris, such as cigarettes, matches or hot ashes
- Go slowly on inclines and slippery surfaces.
- Do not scrub on ramp inclines that exceed 10% grade or transport (GVWR) on ramp inclines that exceed 14% grade.
- Reduce speed when turning.
- Keep all parts of body inside operator station while machine is moving.
- Always be aware of surroundings while operating machine.
- Do not access the video / help screens while the machine is moving. (Pro-Panel).
- Use care when reversing machine.
- Keep children and unauthorized persons away from machine.
- Do not carry passengers on machine.
- Always follow safety and traffic rules.
- Report machine damage or faulty operation immediately.
- Follow mixing, handling and disposal instructions on chemical containers.
- Follow safety guidelines concerning wet floors.

### 5. Before leaving or servicing machine:

- Do not park near combustible materials, dusts, gases, or liquids.
- Stop on level surface.
- Set parking brake.
- Turn off machine and remove key.

### 6. When servicing machine:

- All work must be done with sufficient lighting and visibility.
- Keep work area well ventilated.
- Avoid moving parts. Do not wear loose clothing, jewelry and secure long hair.
- Block machine tires before jacking machine up.
- Jack machine up at designated locations only. Support machine with jack stands.
- Use hoist or jack that will support the weight of the machine.
- Do not push or tow the machine without an operator in the seat controlling the machine.
- Do not power spray or hose off machine near electrical components.

- Disconnect battery connections before working on machine.
- Avoid contact with battery acid.
- Avoid contact with hot engine coolant.
- Do not remove cap from radiator when engine is hot.
- Allow engine to cool.
- Keep flames and sparks away from fuel system service area. Keep area well ventilated.
- Use cardboard to locate leaking hydraulic fluid under pressure.
- All repairs must be performed by a trained service mechanic.
- Do not modify the machine from its original design.
- Use Tennant supplied or approved replacement parts.
- Wear personal protective equipment as needed and where recommended in this manual.



For Safety: wear hearing protection.



For Safety: wear protective gloves.



For Safety: wear eye protection.



For Safety: wear protective dust mask.

### 7. When loading/unloading machine onto/off truck or trailer:

- Use ramp, truck or trailer that will support the weight of the machine and operator.
- Drain tanks before loading machine.
- Lower scrub head and squeegee before tying down machine.
- Turn off machine and remove key.
- Do not load/unload on ramp inclines that exceed 10 deg/18% grade.
- Set parking brake after machine is loaded.
- Block machine tires.
- Tie machine down to truck or trailer.

# SAFETY PRECAUTIONS

The following safety labels are mounted on the machine in the locations indicated. If these or any labels become damaged or illegible, install a new label in its place.

**WARNING LABEL –**  
Flammable materials or reactive metals can cause explosion or fire. Do not pick up.

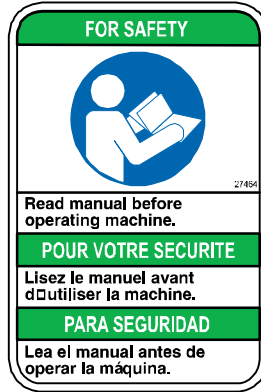

Located on the side of the operator compartment.

**FOR SAFETY LABEL –**  
Read manual before operating machine

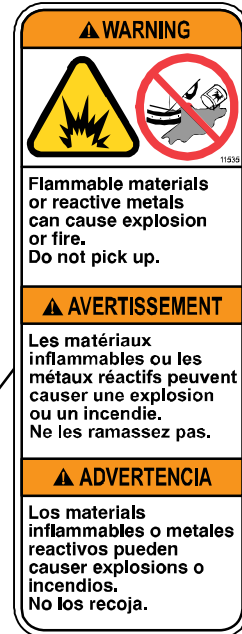

Located on the side of the operator compartment.

**WARNING LABEL –** Do not spray people or animals. Severe personal injury can result. Wear eye protection. Hold sprayer with both hands.



Located on frame of machine.

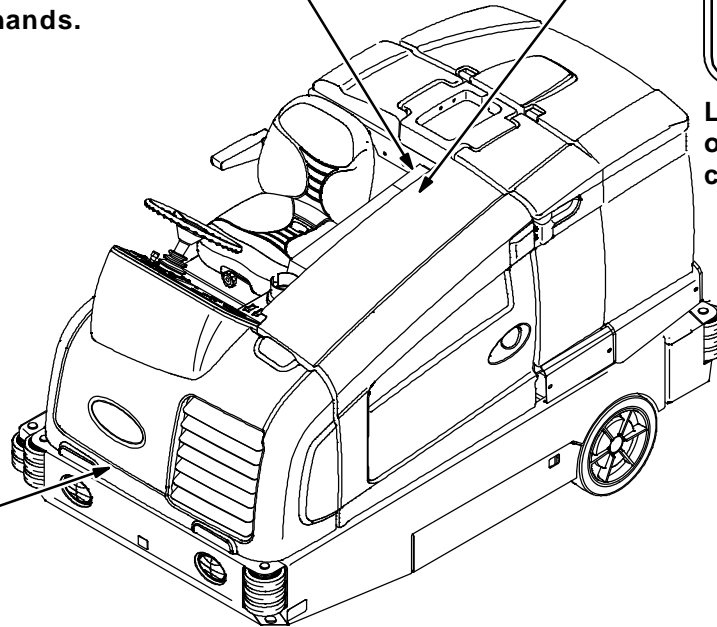

**WARNING LABEL – Machine emits toxic gases. Serious injury or death can result. Provide adequate ventilation.**

	<b>▲ WARNING</b>	<b>▲ AVERTISSEMENT</b>	<b>▲ ADVERTENCIA</b>
	Machine emits toxic gases. Serious injury or death can result. Provide adequate ventilation.	La machine produit des gaz toxiques. Ces gaz peuvent provoquer des blessures ou la mort. Veillez à ce que l'endroit soit bien aéré.	La máquina emite gases tóxicos. Pueden provocar lesiones graves o fatales. Asegúrese de que existe suficiente ventilación.
	1C28721		

Located on the side of the operator compartment.

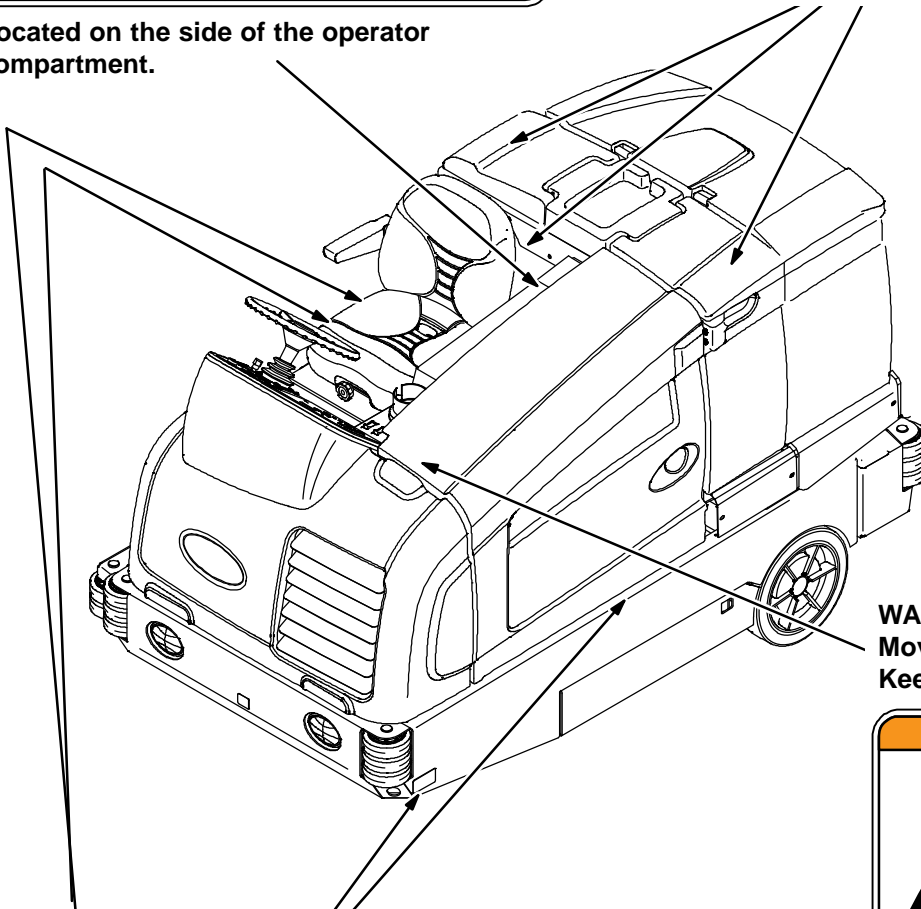

**WARNING LABEL – Flammable materials can cause explosion or fire. Do not use flammable materials in tank.**

	<b>▲ WARNING</b>	<b>▲ AVERTISSEMENT</b>	<b>▲ ADVERTENCIA</b>
	Flammable materials can cause explosion or fire. Do not use flammable materials in tank.	Les matières inflammables peuvent causer une explosion ou un incendie. N'utilisez pas de matières inflammables dans le(s) réservoir(s).	Los materiales inflamables pueden provocar explosiones o incendios. No utilice materiales inflamables en el depósito(s).
	1C28721		

Located next to the solution tank covers and on the detergent tank.

**WARNING LABEL – Burn hazard. Hot surface. Do NOT touch**

	<b>▲ WARNING</b>
	Burn hazard. Hot surface. Do NOT touch.
	<b>▲ AVERTISSEMENT</b>
Risque de brûlures. Surface chaude. Ne pas toucher.	<b>▲ ADVERTENCIA</b>
Peligro de quemaduras. Superficie caliente. NO tocar.	

Located on the side of the bumper, on the exhaust shield, on the hydraulic reservoir, and on the scrub head (disk head machines only).

**WARNING LABEL – Moving belt and fan. Keep away.**

<b>▲ WARNING</b>

Moving belt and fan. Keep away.
<b>▲ AVERTISSEMENT</b>
La courroie et le ventilateur sont en mouvement. Ne vous approchez pas.
<b>▲ ADVERTENCIA</b>
Correa y ventilador en movimiento. Manténgase alejado.

Located on engine compartment panel.

**MACHINE COMPONENTS**



- A. Overhead guard (option)
- B. Instrument panel
- C. Front shroud
- D. Headlights
- E. Side brush (option)
- F. Side squeegee
- G. Scrub head access door
- H. Debris tray carriage release lever
- I. Fuel tank
- J. Seat shroud
- K. FaST carton, or ES detergent tank, Detergent metering tank, or ec-H2O System Module (option)

- L. Solution tank cover
- M. Operator seat
- N. Spray wand – nozzle behind seat (option)
- O. Flashing light (option)
- P. Audible backup alarm (option)
- Q. Recovery tank drain hose
- R. Recovery tank cover
- S. Solution tank drain hose
- T. Debris tray carriage
- U. Taillights
- V. Rear squeegee
- W. Engine cover

## CONTROLS AND INSTRUMENTS

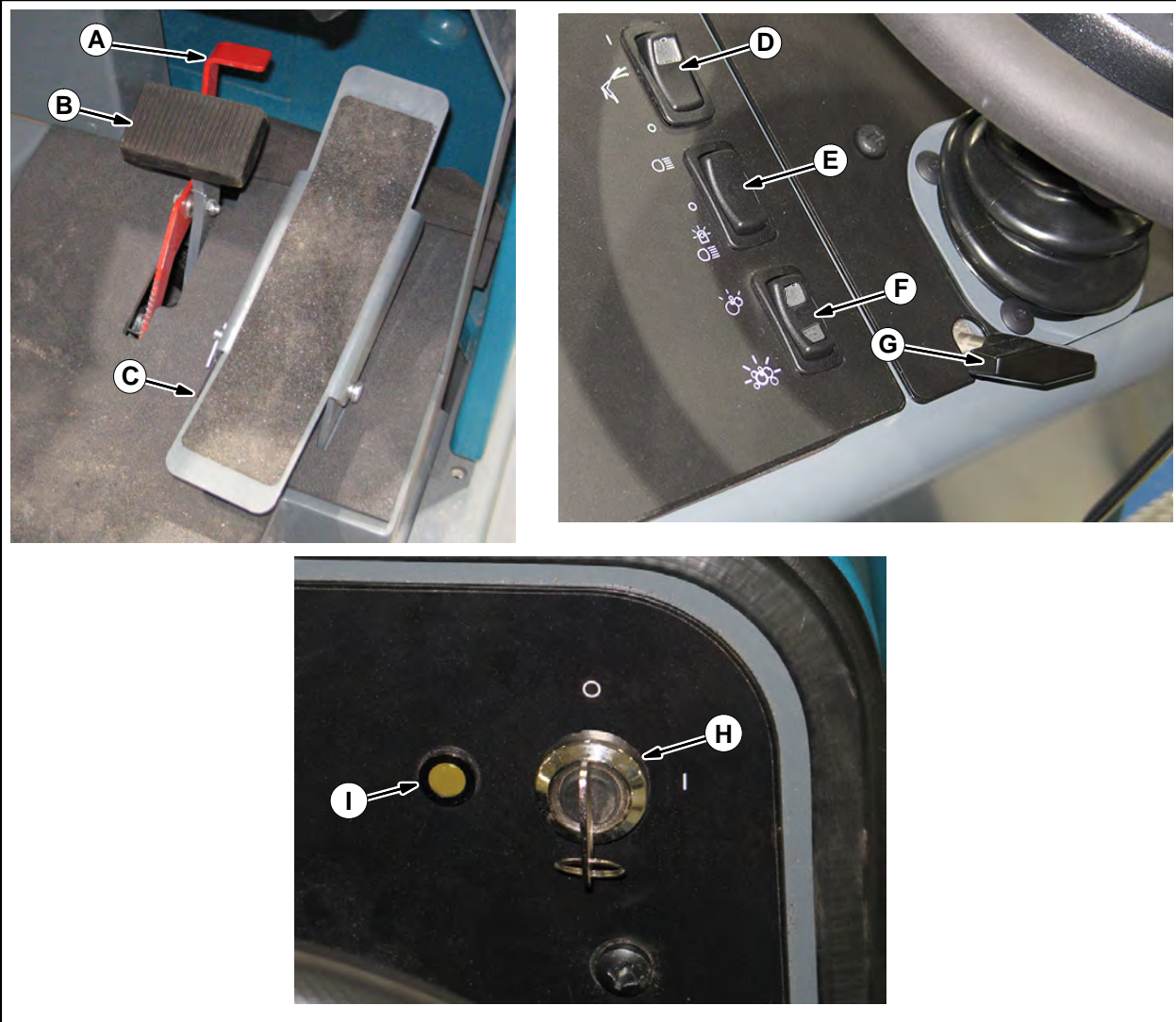

- A. Parking brake pedal
- B. Brake pedal
- C. Directional pedal
- D. Spray nozzle switch /  
High pressure washer switch (option)
- E. Operating / Hazard lights switch
- F. Detergent metering switch (option)
- G. Steering column tilt knob
- H. Ignition switch
- I. Glow plug light

## STANDARD TOUCH PANEL

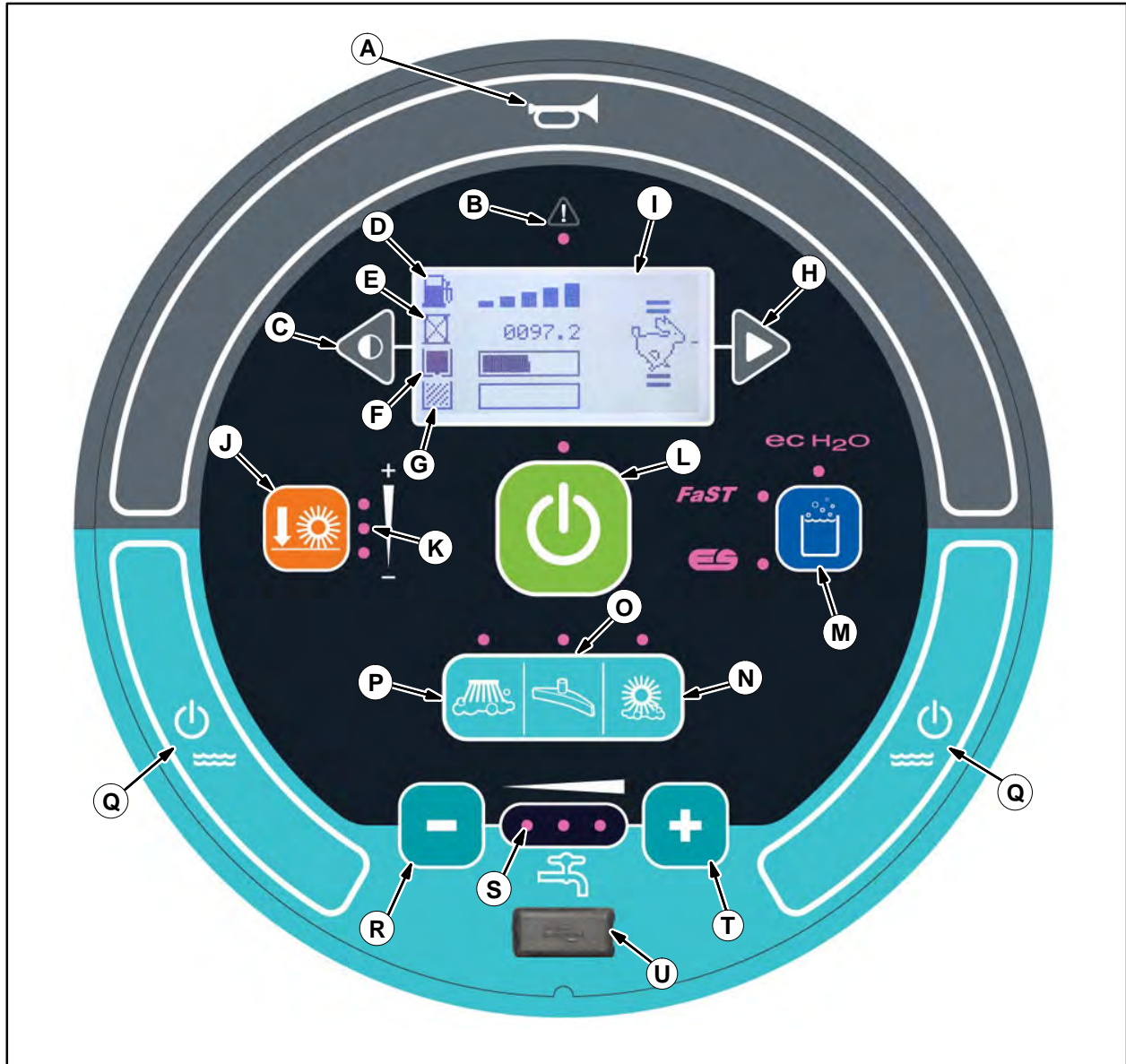

- A. Horn
- B. Fault / Alert indicator light
- C. Contrast control button
- D. Fuel level indicator
- E. Hour meter
- F. Solution tank indicator
- G. Recovery tank full indicator
- H. Engine speed button
- I. LCD display
- J. Brush pressure button
- K. Brush pressure indicator lights

- L. 1-STEP button
- M. ec-H<sub>2</sub>O / ES (Extended Scrub / FaST button (Option)
- N. Scrubbing main brush button
- O. Scrubbing vacuum fan / squeegee button
- P. Scrubbing side brush (Option)
- Q. Solution on / off buttons
- R. Solution flow decrease button (-)
- S. Solution flow indicator lights
- T. Solution flow increase button (+)
- U. USB port (Service only)

**PRO-PANEL CONTROLS**

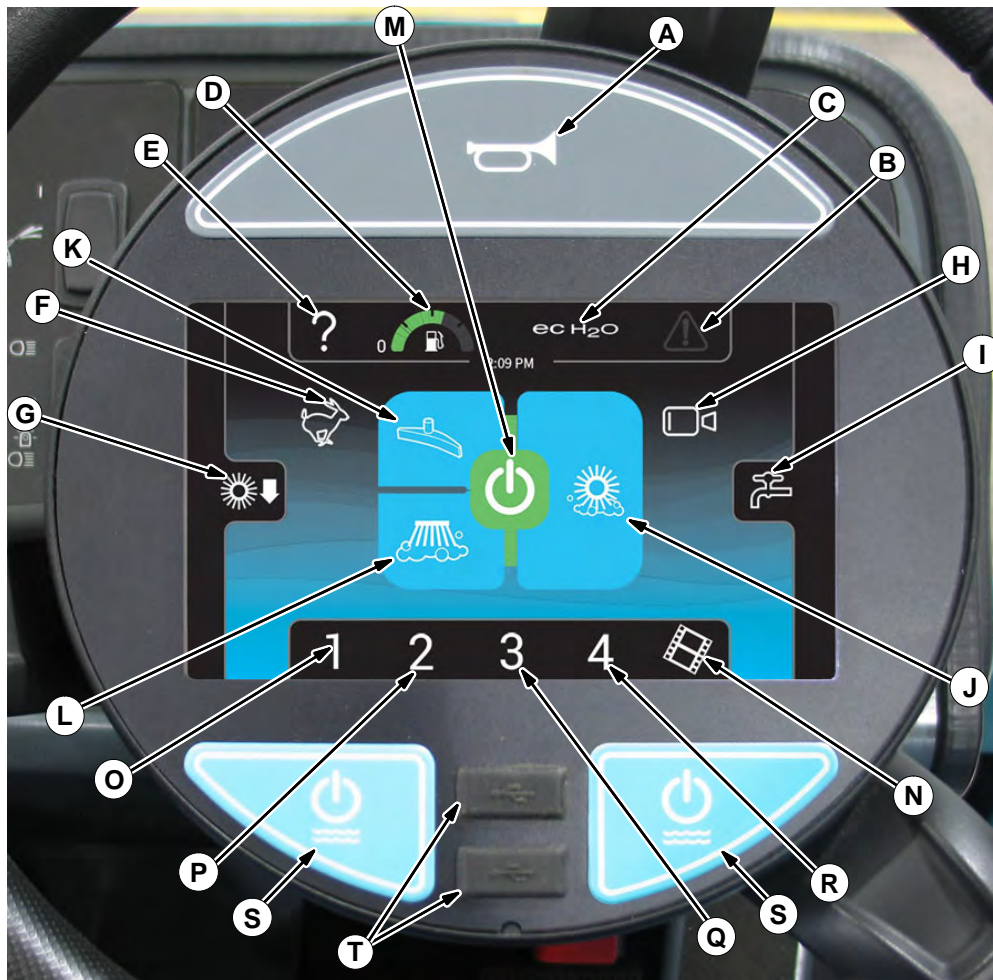





















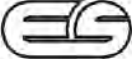
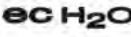

- |   |   |
|---|---|
| <ul style="list-style-type: none"> <li>A. Horn</li> <li>B. Fault / Alert indicator light</li> <li>C. ec-H<sub>2</sub>O / ES (Extended Scrub / FaST button (Option)</li> <li>D. Machine status button</li> <li>E. Help button</li> <li>F. Engine speed button</li> <li>G. Main brush pressure access button</li> <li>H. Rearview camera button</li> <li>I. Solution control access button</li> <li>J. Scrubbing main brush button</li> </ul> | <ul style="list-style-type: none"> <li>K. Scrubbing vacuum fan / squeegee button</li> <li>L. Scrubbing side brush (Option)</li> <li>M. 1-STEP button</li> <li>N. Video help</li> <li>O. Zone control 1 button</li> <li>P. Zone control 2 button</li> <li>Q. Zone control 3 button</li> <li>R. Zone control 4 button</li> <li>S. Solution on / off buttons</li> <li>T. USB ports (Service only)</li> </ul> |
|---|---|

# OPERATION

## SYMBOL DEFINITIONS

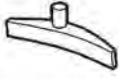
These symbols are used on the machine to identify controls, displays, and features.

	Horn		Solution decrease (-)
	Fault / Alert indicator		Solution increase (+)
	Recovery tank		Solution flow
	Solution tank		Solution On / Off
	Main brush pressure		On
	1-STEP		Off
	ES (Extended Scrub) (Option)		ec-H <sub>2</sub> O (Option)
<b>FaST</b>	FaST (Option)		Jack point
	Scrub mode		Spray nozzle (Option)
	Operating lights / Hazard light		Hour meter
	Headlights		Scrubbing main brush
	Scrubbing side brush		Scrubbing vacuum fan / squeegee
	Detergent metering low rate		Detergent metering high rate

Standard Panel Symbols



Contrast control



Engine speed control

Pro-Panel Symbols



Help



Zone setting 1



Zone setting 2



Zone setting 3



Zone setting 4



Hour meter



Alert / Fault



Checklist item unconfirmed



Hour meter



Checklist item confirmed



Login



Logout



Select



Supervisor settings



Rotate machine view



Supervisor menu



Camera settings



Start-up video



Control help



Video help



About



Video button

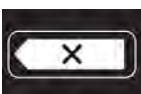

Backspace



Video list button



Rearview camera



Home (main operating screen)

## Pro-Panel Symbols



Up arrow



Down arrow



Disable login



Back arrow



Add / Edit profiles



Enable login



Operator



Calibrate touch



Supervisor



Checklist setup



Edit profile



Export all



Add profile



Export new



Delete profile



Export checklists



Copy profile



Enter

**OPERATION OF CONTROLS – STANDARD PANEL**

**FUEL INDICATOR**

For gasoline machines, the *Fuel indicator* displays the amount of fuel left in the tank. The fault indicator will flash and a low fuel message will appear when the tank is near empty.

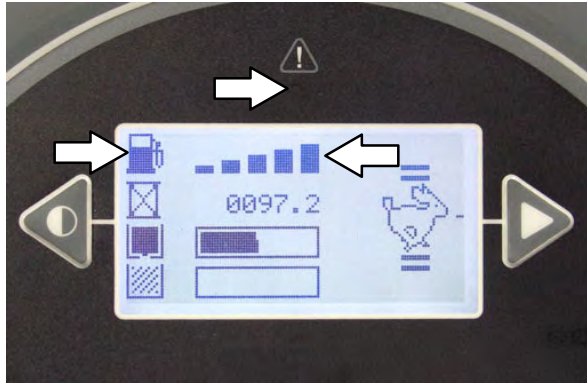

**HOUR METER**

The *Hour meter* records the hours the machine was operated. Use this information to determine machine service intervals.

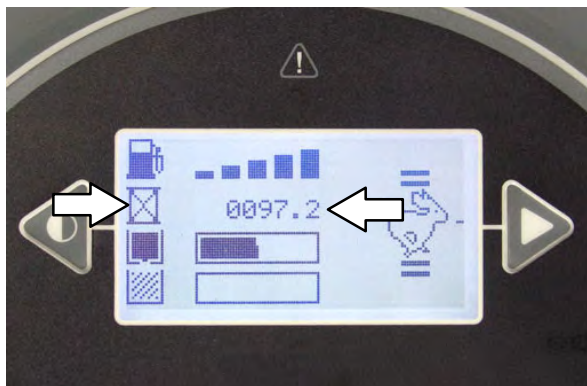

**RECOVERY TANK FULL INDICATOR**

The *recovery tank full indicator* displays when the recovery tank is full. All scrubbing functions will stop when the recovery tank is full. Empty the recovery tank when the indicator box is filled.

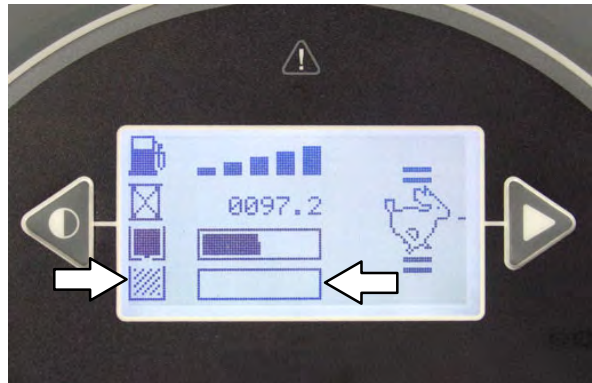

**SOLUTION TANK INDICATOR**

The *solution tank indicator* displays the amount of liquid in the solution tank. Refill the solution tank when the indicator box is empty. The machine will stop scrubbing when the solution tank is empty.

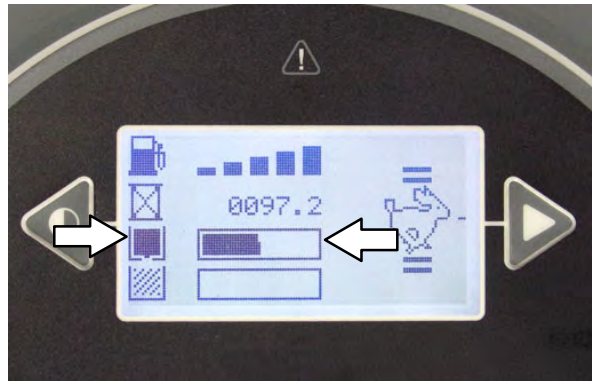

**CONTRAST CONTROL BUTTON**

Use the *contrast control button* to darken / lighten the LCD display.



## OPERATION

### ENGINE SPEED BUTTON

The engine speed is controlled automatically when the *1-STEP button* is pressed. When not scrubbing, press the *engine speed button* to increase the engine RPM for increased travel speed. Press the *engine speed button* again to reduce the engine RPM.

The bars above and below the engine speed icon indicate engine speed setting. When two thinner bars appear above and below the icon and the icon appears as a line figure the engine is in the low setting.

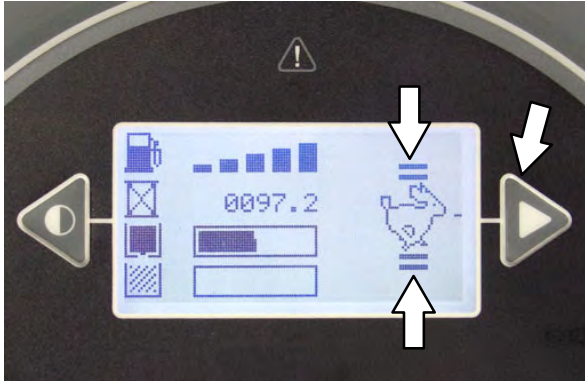

When two thicker bars appear above and below the engine speed icon and the thinner bars and the icon is solid the engine is in the high setting.

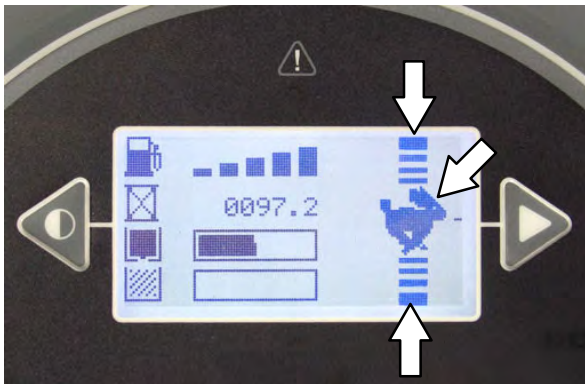

### 1-STEP BUTTON

Press the *1-STEP button* to activate all selected scrubbing functions. Prior to the *1-STEP button* being pushed, the lights above all the selected scrubbing functions will be on but the selected functions will be in the standby mode until the *1-STEP button* is pressed. Press the *1-STEP button* again when finished cleaning to stop all scrubbing functions.

*NOTE: The squeegee will remain down and the vacuum fan will remain on for a few seconds to pick up remaining water after the 1-STEP button is deactivated.*

The indicator light above the button will illuminate when the *1-STEP button* is activated.

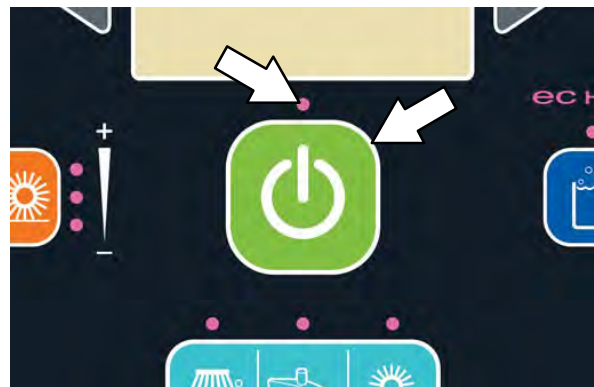

**SCRUBBING SIDE BRUSH BUTTON (OPTION)**

Turn on the scrubbing side brush: Press the *scrubbing side brush button*. The indicator light will illuminate.

Turn off the scrubbing side brush: Press the *scrubbing side brush button*. The indicator light will turn off.

*NOTE: The scrubbing side brush cannot operate independently from the main scrub brushes. The main scrub brushes also come on when the scrubbing side brush button is pushed.*



**SCRUBBING VACUUM FAN / SQUEEGEE BUTTON**

Lower squeegee and turn vacuum fan on: Press the *scrubbing vacuum fan / squeegee button*. The indicator light will illuminate.

Raise squeegee and turn vacuum fan off: Press the *scrubbing vacuum fan / squeegee button*. The indicator light will turn off.



**SCRUBBING MAIN BRUSH BUTTON**

Turn on the scrubbing main brush: Press the *scrubbing main brush button*. The indicator light will illuminate.

Turn off the scrubbing main brush: Press the *scrubbing main brush button*. The indicator light will turn off.



**SOLUTION ON / OFF BUTTON**

The solution flow is designed to stay on whenever the scrub brushes are on. It can be turned off for 10 seconds with the *solution on / off button* to go around corners, etc. See also *SETTING THE SOLUTION FLOW* section.

Shut off the solution flow (for 10 seconds) : Press the *solution on / off button*. All the solution flow indicators will turn off. (The solution flow will automatically restart at the end of the 10 second delay).

Turn on the solution flow: Press the *solution on / off button*. The solution indicators will turn back on and the solution flow will default to the last setting used.



# OPERATION

## OPERATION OF CONTROLS – PRO-PANEL

### PRO-ID LOGIN SCREEN

*NOTE: The Pro-ID login screen only applies if the machine was set up with it. Predefined user accounts must be created within the Supervisor Mode.*

Use the Pro-ID login screen to log into the machine.

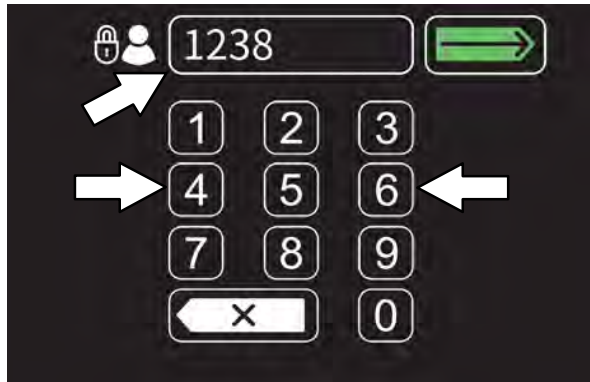

Use the keypad to enter the user login number into the display above the keypad.

 Press the Enter button to log into the machine.

 Press the backspace button if necessary to delete and reenter a number.

When the Pro-Panel is in the Supervisor Mode, a gear symbol will appear in the lower right part of the screen. When it is in the Operator Mode, a video symbol will appear.





### MACHINE STATUS BUTTON

The *machine status button* allows access to four different machine status indicators. The default display shows the fuel indicator when the machine is turned on. Any of the four indicators can be set as the default display until the machine is turned off.

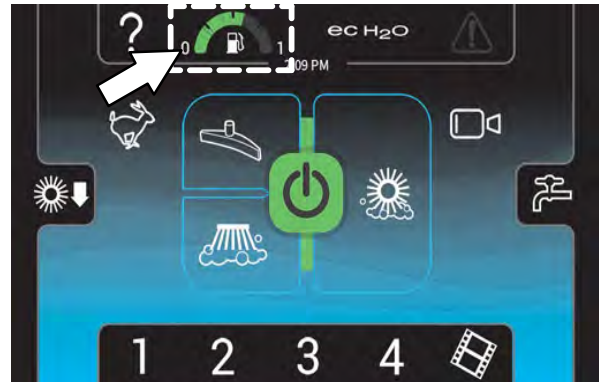
Press the *machine status button* to access all four machine status buttons. All four machine status buttons appear in the display for several seconds until the default buttons reappear in the display.



 The *Fuel indicator* displays the amount of fuel left in the tank. The fault indicator will flash and a low fuel message will appear when the tank is near empty.

 The *hour meter* records the hours the machine was operated. Use this information to determine machine service intervals.



The *solution tank indicator* displays the amount of liquid in the solution tank. Refill the solution tank when there are no longer any bars shown in the display. The machine will stop scrubbing when the solution tank is empty.



The *recovery tank full indicator* displays FULL when the recovery tank is full. All scrubbing functions will stop when the recovery tank is full. Empty the recovery tank when the indicator displays FULL.

**CHANGING THE DEFAULT BUTTON**

Press the desired machine status button while all four machine status buttons appear in the display to change it to the new default button. The other three machine status buttons will disappear from the display and the newly selected machine status button will become the default until the machine is turned off. The *fuel indicator button* will once again be the default when the machine is turned on.

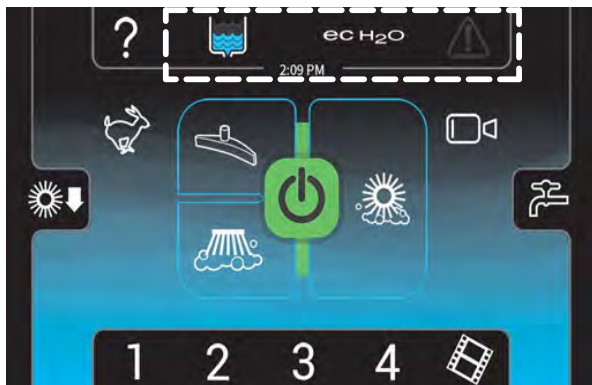
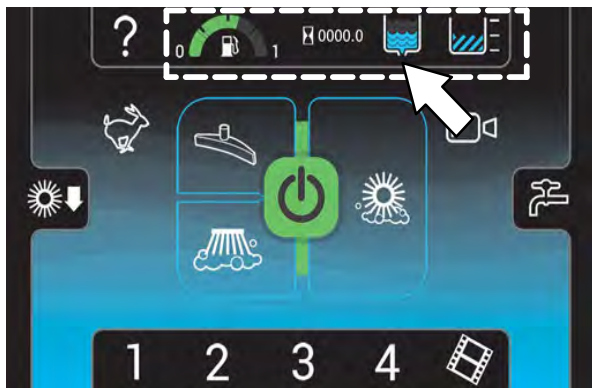

**1-STEP BUTTON**

Press the *1-STEP button* to activate all selected scrubbing functions. Press the *1-STEP button* again when finished cleaning to stop all scrubbing functions.

*NOTE: The squeegee will remain down and the vacuum fan will remain on for a few seconds to pick up remaining water after the 1-STEP button is deactivated.*

The *1-STEP button* and all selected scrubbing function buttons will illuminate when the *1-STEP button* is pressed.

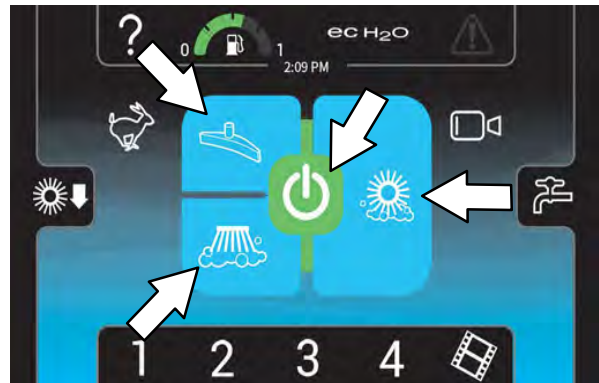

The edges of all selected scrubbing buttons will be illuminated to show that they are in the standby mode prior to the *1-STEP button* being pressed. The selected buttons will become fully illuminated when the *1-STEP button* is pressed.

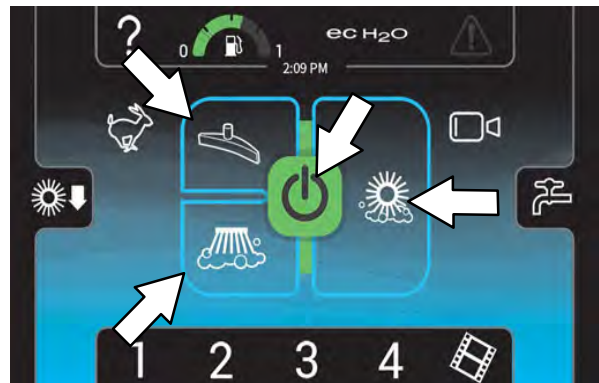

## OPERATION

### SCRUBBING MAIN BRUSH BUTTON

Turn on the scrubbing main brush: Press the *scrubbing main brush button*. The button will illuminate.

Turn off the scrubbing main brush: Press the *scrubbing main brush button*. The button will turn off.

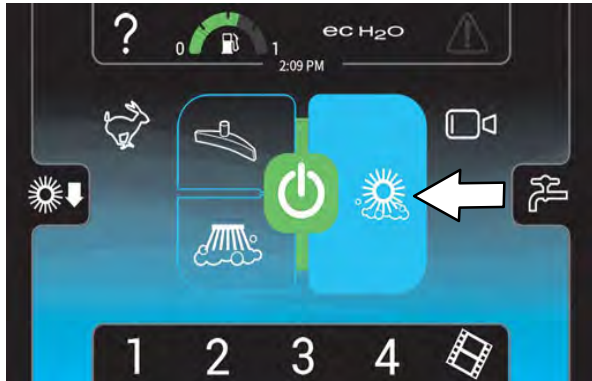

### SCRUBBING VACUUM FAN / SQUEEGEE BUTTON

Lower squeegee and turn vacuum fan on: Press the *scrubbing vacuum fan / squeegee button*. The button will illuminate.

Raise squeegee and turn vacuum fan off: Press the *vacuum fan / squeegee button*. The button will turn off.



### SCRUBBING SIDE BRUSH BUTTON (OPTION)

Turn on the scrubbing side brush: Press the *scrubbing side brush button*. The button will illuminate.

Turn off the scrubbing side brush: Press the *scrubbing side brush button*. The button will turn off.

**NOTE:** The scrubbing side brush cannot operate independently from the main scrub brushes. The main scrub brushes also come on when the scrubbing side brush button is pushed.



### SOLUTION ON / OFF BUTTONS

The solution flow is designed to stay on whenever the scrub brushes are on. It can be turned off for ten seconds with the *solution on / off button* to go around corners, etc. See also *SETTING THE SOLUTION FLOW* section.

Shut off the solution flow (for ten seconds) : Press the *solution on / off button*. All the solution flow indicators will turn off. (The solution flow will automatically restart at the end of the 10 second delay).

Turn on the solution flow: Press the *solution on / off button*. The solution indicators will turn back on and the solution flow will default to the last setting used.

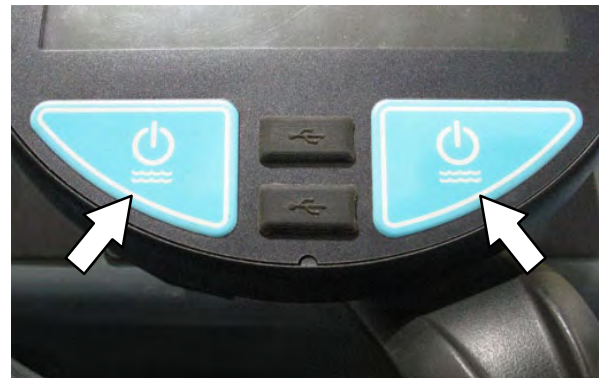

**ENGINE SPEED BUTTON**

The engine speed is controlled automatically when the *1-STEP* button is pressed. When not sweeping or scrubbing, press the *engine speed button* to increase the engine RPM for increased travel speed. Press the *engine speed button* again to reduce the engine RPM.

The *engine speed button* is illuminated when the engine is in the high speed setting.



The *engine speed button* is off when the engine is in the low speed setting.



**ZONE CONTROL BUTTONS**

Machines equipped with the Pro-Panel can be pre-programmed for up to four preset scrubbing settings for different floor cleaning applications. These must be set up ahead of time using the supervisor mode. See *PROGRAMMING THE ZONE CONTROL BUTTONS* section.



Press the required zone control button. The selected preset button will illuminate and the name of the zone appears above the button. The *solution flow indicator bar* / adjustment buttons and *brush pressure indicator bar* / adjustment buttons briefly appear in the display to show the settings for the selected zone.



## OPERATION

### REARVIEW CAMERA BUTTON

Press the *rearview camera button* to check cleaning performance. The rearview camera screen will appear in the control panel display for a short amount of time. The main operating screen returns to the control panel after the rearview camera times out. Touch anywhere on the control panel display to turn off the rearview camera and return to the main operating screen.

**FOR SAFETY: When using machine, always be aware of your surroundings.**



The camera automatically comes on when the bottom of the *directional pedal* is pressed to place the machine in reverse and remains on the entire time the machine is in reverse.

The rearview camera is located on the recovery tank, above where the vacuum hose is attached to the recovery tank.

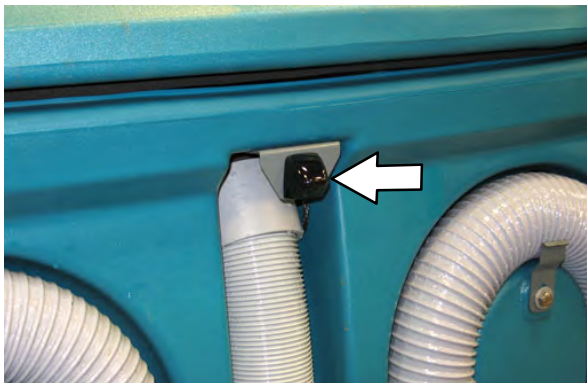

**HELP BUTTON**

**FOR SAFETY: When using machine, do not access the video / help screens while the machine is moving. (Pro-Panel)**

Press the *help* button to access the help screen.





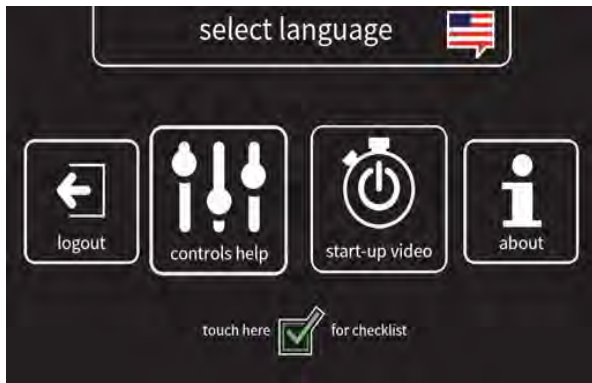

Press the applicable button for the help topic needed.



-  Press the *select language* button to go to the language screen.
-  Press the *login / logout* button to log in / log out of the machine operating system.
-  Press the *controls help* button to access the controls help screen.
-  Press the *start-up video* button to watch the start-up video.
-  Press the *about* button to access machine operating system information.
-  Press the *Pre-Operation Checklist* button to access the Pre-Operation Checklist.



Press the select language button. Select an applicable language from the list to change the machine operating system language. A flag designating the country language selected will appear at the top of the screen.

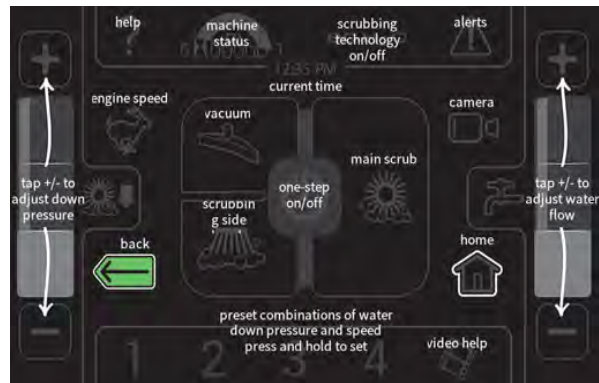

-  Press the *down arrow* button to scroll down through the language list.
-  Press the *up arrow* button to scroll up through the language list.
-  Press the *back arrow* button to return to the previous screen
-  Press the *Pre-Operation Checklist* button to access the Pre-Operation Checklist.

Press the *control help* button to access information about the Pro-Panel controls.







-  Press the *back arrow* button to return to the main help screen.
-  Press the *home* button to return to the main operating screen.

## OPERATION

Press the *about button* to access information about the operating system software.



-  Press the *down arrow button* to scroll down through the list.
-  Press the *up arrow button* to scroll up through the list.
-  Press the *Pre-Operation Checklist button* to access the Pre-Operation Checklist.
-  Press the *back arrow button* to return to the previous screen.
-  Press the *home button* to navigate back to the main operating screen.





**VIDEO HELP BUTTON**

**FOR SAFETY: When using machine, do not access the video / help screens while the machine is moving. (Pro-Panel)**

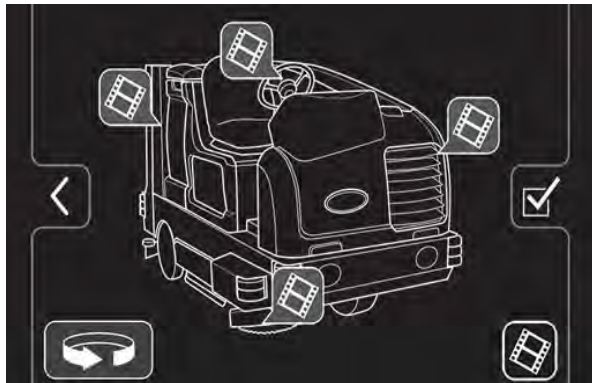
*NOTE: Stop machine before accessing video help screen / videos. Do Not access the video help screen / videos while the machine is moving.*





Press the *video button* to access the video help screen.



-  Press the applicable *video button* to view the help video for a particular machine component.
-  Press the *rotate machine button* to access video help buttons located at the front, back, or side of the machine.
-  Press the home button to return to the main operating screen.
-  Press the *back arrow button* to return to the previous screen.
-  Press the *video list button* to access a text list of all help videos.

Select an applicable video from the list to view the video if the *video list button* was pressed to access the video list.







-  Press the *down arrow button* to scroll down through the list.
-  Press the *up arrow button* to scroll up through the list.
-  Press the *Pre-Operation Checklist button* to access the Pre-Operation Checklist.
-  Press the *back arrow button* to return to the previous screen.

## OPERATION

### COMPLETING THE PRO-CHECK PRE-OPERATION CHECKLIST

Machines equipped with the Pro-Panel controls can be pre-programmed with the Pro-Check Pre-Operation Checklist the operator must complete before operating the machine.



-  Press the *down arrow button* to scroll down through the checklist.
-  Press the *up arrow button* to scroll up through the checklist.
-  Press the *complete (check mark) button* to confirm the checklist item was checked. Press the *problem found (X) button* if a problem is found when checklist item is checked.
-  Press the *video help button* to view the video related to a particular checklist item.
-  Press the *Enter button* to log into the machine.

 Press the *help button* to access the Pro-Check Pre-Operation Checklist help screen.



 Press the *back button* to return to the Pre-Operation Checklist.

The operator is not allowed to access the main operating screen / use machine until the Pro-Check Pre-Operation Checklist is completed. Press the *back arrow button* to return to the checklist screen.

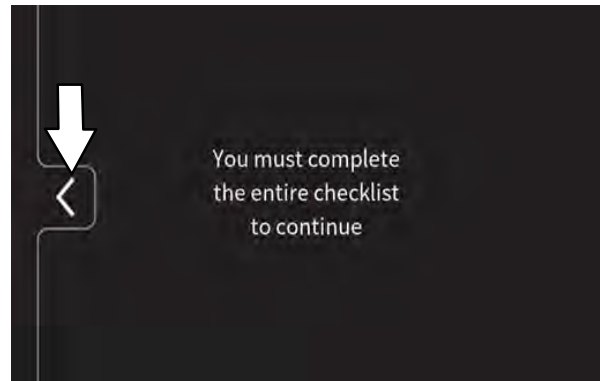

---

**OPERATION OF CONTROLS – ALL MACHINES**

---

**OPERATING LIGHTS**

Push the top of the *Operating / hazard light* switch to turn on the headlights and taillights. Return the light switch to the center position to turn off the lights.

**HAZARD LIGHT (OPTION)**

Press the bottom of the *Operating / hazard light* switch to turn on the hazard light, headlights, and taillights. Return the light switch to the center position to turn off the lights.

**GLOW PLUG LIGHT (PREHEAT)**

The *Glow plug light* comes on when the ignition switch is turned counterclockwise to the preheat position. The light will stay on when the key is held in this position.

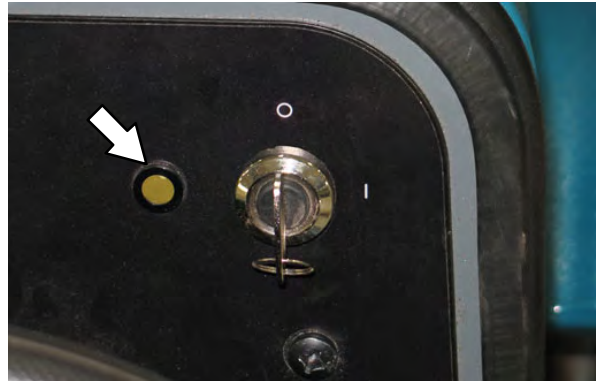

## OPERATION

### OPERATOR SEAT

The operator seat has two adjustments: operator weight and front to back.

The weight adjustment knob controls the firmness of the operator seat.



Increase firmness: Turn the weight adjustment knob clockwise.

Decrease firmness: Turn the weight adjustment knob counterclockwise.

The front-to-back adjustment lever adjusts the seat position.



Adjust: Push to lever in towards the seat and slide the seat to the desired position. Release the lever to lock the seat into place.

### SEAT BELTS

Always fasten and adjust the *seat belts* before operating the machine.



### STEERING COLUMN TILT KNOB

1. Pull the *Steering column tilt knob* and adjust the steering column to the desired height.
2. Release the *Steering column tilt handle*.

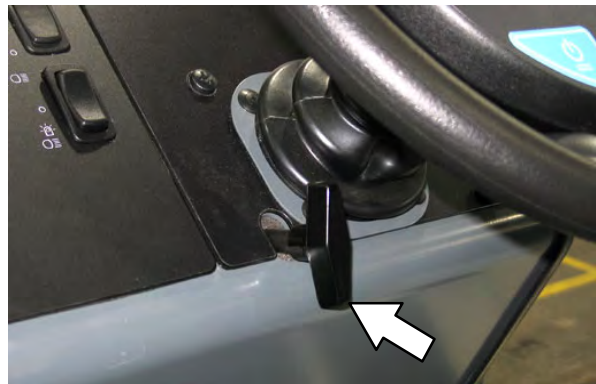

**BRAKE PEDAL**

Press the *Brake pedal* to stop the machine.

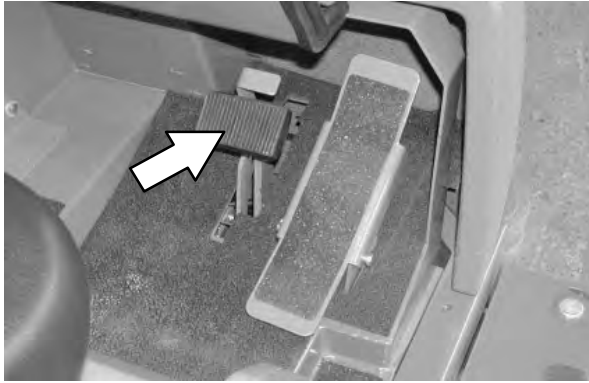

**PARKING BRAKE PEDAL**

Press the *Brake pedal* down as far as possible and use toe to lock the *Parking brake pedal* into place. Press the *Brake pedal* to release the parking brake. The *Parking brake pedal* will return to the unlocked position.

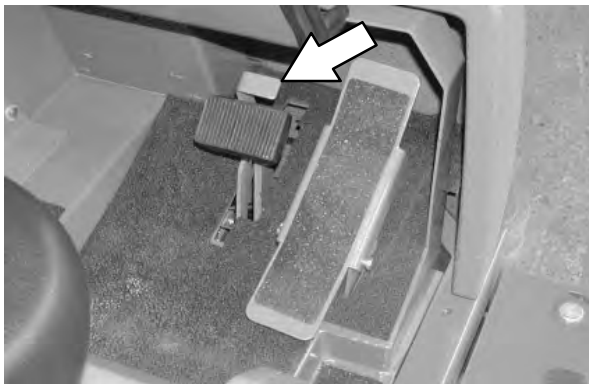

**DIRECTIONAL PEDAL**

Press the top of the *Directional pedal* to move forward and the bottom of the pedal to move backward. The backup lights will come on when the machine is in reverse. The pedal returns to the neutral position when it is released.

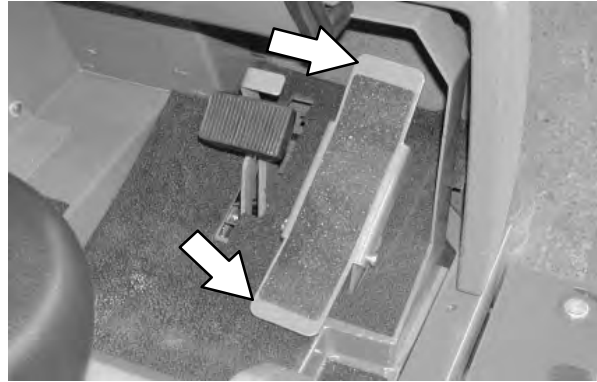

*NOTE: An audible alarm will sound and the backup light will flash when backing the machine if equipped with the optional backup alarm.*

**SQUEEGEE PROTECTORS (OPTION)**

The rear and side squeegee protectors help protect the rear squeegee from being damaged.

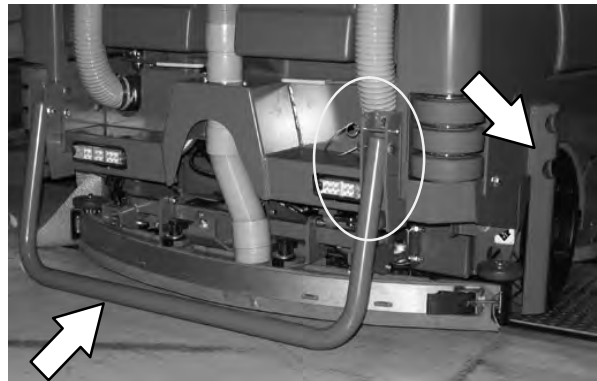

To engage the rear squeegee protector, pull the pin, lower the protector bar, and reinsert the pin.



# OPERATION

## HOW THE MACHINE WORKS



This machine can effectively scrub dirty floors. The *1-STEP button* makes it possible to immediately begin scrubbing by operating all the scrubbing functions.

When in the conventional Scrub mode, a water and detergent mixture is used to scrub the floor.

The Detergent Metering option can provide an increased detergent flow for areas with extraordinary dirt or soil buildup.

When in the optional FaST (Foam scrubbing) mode, the FaST scrubbing system mixes the FaST-PAK concentrate with a small amount of water, creating a large volume of expanded wet foam. The FaST system can be used with all scrubbing applications.



When in the optional ES (Extended Scrub) mode, the dirty solution in the recovery tank is filtered through the ES system and returned to the solution tank for reuse. Detergent is then injected into the returned solution to revitalize the cleaning capability of the solution.

When in the optional *ec-H<sub>2</sub>O* (electrically converted water) mode, normal water passes through a module where it is oxygenated and charged with an electric current. The electrically converted water changes into a blended acidic and alkaline solution forming a neutral pH cleaner. The converted water attacks the dirt, breaks it into smaller particles, and pulls it off the floor surface allowing the machine to easily scrub away the suspended soil. The converted water then returns to normal water in the recovery tank. The *ec-H<sub>2</sub>O* system can be used while double scrubbing.

---

**BRUSH AND PAD INFORMATION**

---

For best results, use the correct brush type for the cleaning application. Listed below are the brushes and the applications for which each is best suited.

*NOTE: The amount and type of soilage play an important role in determining the type of brushes to use. Contact a Tennant representative for specific recommendations.*

**Nylon brush (Disk)\*** – Softer nylon bristles are recommended for scrubbing coated floors. Cleans without scuffing.

**Polyester brush (Cylindrical)** – Softer general purpose polyester bristles gently clean while scrubbing. Perfect for sensitive floor surfaces. Polyester does not absorb water so it is preferred over Nylon in wet applications.

**PolyPro brush (Cylindrical)** – Heavy duty polypropylene bristles provide a more aggressive cleaning performance and can more easily lift compacted dirt, debris, and sand while offering excellent scrubbing performance.

**Polypropylene brush (Cylindrical and Disk)\*** – General purpose polypropylene bristles lift lightly compacted dirt without scuffing high-gloss coated floors.

**Super AB brush (Cylindrical and Disk)\*** – Nylon fiber impregnated with abrasive grit to remove stains and compacted dirt. Aggressive action on any surface. Performs well on buildup, grease, or tire marks.

*\* This brush is also available for the side brush.*

**Stripping pad** – This brown pad is for stripping floors. Quickly and easily cuts through old finish to prepare the floor for recoating.

**Scrubbing pad** – This blue pad is for scrubbing floors. Removes dirt, spills, and scuffs. Leaves a clean surface ready for re-coating.

**Buffing pad** – This red pad is for buffing floors. Quickly cleans and removes scuff marks while polishing the floor to a high gloss.

**Polishing pad** – This white pad is for polishing floors. Maintains a high gloss. Use for buffing very soft finishes and lower traffic areas, and polishing soft waxes on wood floors.

**High productivity pad** – This black pad is for aggressively stripping floor finishes/sealers or for very heavy-duty scrubbing. *This pad can only be used with the grip pad driver, not the tufted pad driver.*

**Surface preparation pad** – This maroon pad is for very aggressive floor stripping without chemicals.

**Grip pad driver** – The grip-face backing allows pads to be fully used and holds pads in place without penetrating the pad. The spring-activated centering device works with all Tennant pads and allows for fast, easy pad replacement.



**Tufted pad driver** – Standard pad driver has short bristles, or “tufts,” on the back to hold the pad in place. This driver works with all Tennant pads except the black high productivity pad.

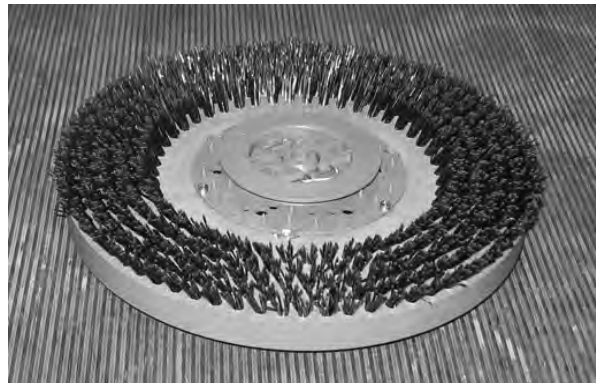

## WHILE OPERATING THE MACHINE

---

Pick up oversized debris before scrubbing. Pick up wire, string, plastic wrap, twine, large pieces of wood, or any other debris that could become wrapped around or tangled in the brushes. Do not use where excessive debris is present such as leaves, paper, etc.

Drive as straight a path as possible. Avoid bumping into posts or scraping the sides of the machine. Overlap the scrub paths by several centimeters (a few inches).

Avoid turning the steering wheel too sharply when the machine is in motion. The machine is very responsive to the movement of the steering wheel. Avoid sudden turns, except in emergencies.

Adjust the machine speed, brush pressure, and solution flow as required when scrubbing. Use the lowest brush pressure and solution flow settings for best performance. If the machine is equipped with the FaST or ec-H2O system, use the FaST or ec-H2O system for the best scrubbing results.

Keep the machine moving to prevent damaging floor finishes.

If poor cleaning performance is observed, stop cleaning and refer to *MACHINE TROUBLESHOOTING* in this manual.

Perform the Daily Maintenance Procedures after each use (see *MACHINE MAINTENANCE* in this manual).

Drive the machine slowly on inclines. Use the brake pedal to control machine speed on descending inclines. Scrub with the machine up inclines rather than down inclines.

**FOR SAFETY: When using machine, go slowly on inclines and slippery surfaces.**

Do not operate machine in areas where the ambient temperature is above 43° C (110° F). Do not operate scrubbing functions in areas where the ambient temperature is below freezing 0° C (32° F).

**FOR SAFETY: When using machine, do not scrub on ramp inclines that exceed 10% grade or transport (GVWR) on ramp inclines that exceed 14% grade..**

---

**PRE-OPERATION CHECKLIST**

---

- Check the hydraulic fluid level.
  - Check the fuel level.
  - Check the machine for fluid leaks.
  - Check the condition of the main brushes. Remove string, banding, plastic wrap, or other debris wrapped around the brushes.
  - Cylindrical brushes: Check that the debris tray is empty and clean.
  - Check the main brush compartment right skirts, seals, and squeegee for damage and wear.
  - Side Brush Option: Check the condition of the brush. Remove string, banding, plastic wrap, or other debris wrapped around the brush.
  - Side Brush Option: Check the condition of the side brush squeegee.
  - Check the radiator and hydraulic cooler fins for debris.
  - Check the engine coolant level.
  - Check the engine oil level.
  - Check the main brush compartment left skirts, seals, and squeegee for damage and wear.
  - Check the left solution tank cover seal for damage and wear.
  - Check the recovery tank cover seal for damage and wear.
  - Clean the vacuum fan debris filter.
  - Drain and clean the recovery tank.
  - ES Option: Drain and clean the solution tank, float sensor, and ES filter.
  - Check the right solution tank cover seal for damage and wear.
  - Check the squeegee hose for debris or blockage.
  - Check the squeegees for damage, wear, and deflection adjustment.
- FaST Scrubbing: Check the FaST-PAK concentrate agent level. Replace carton as needed. See the INSTALLING THE FaST-PAK CARTON section of the manual.
  - FaST Scrubbing: Ensure all conventional cleaning agents are drained and rinsed from the solution tank.
  - FaST Scrubbing: Ensure the solution tank is filled with **clear cool water only**.
  - Check the headlights, taillights, and safety lights.
  - Check the brakes and steering for proper operation.
  - Check the service records to determine maintenance requirements.

## OPERATION

### STARTING THE MACHINE

1. Sit in the operator seat and press the brake pedal or set the parking brake.

**FOR SAFETY: When starting machine, keep foot on brake and directional pedal in neutral.**

2. Turn the key counterclockwise. The *glow plug light* will come on. Hold the key in this position for 15 to 30 seconds, depending on weather conditions. Colder weather requires longer time.



3. Turn the key clockwise to start the engine.

*NOTE: Do not operate the starter motor for more than 10 seconds at a time or after the engine has started. Allow the starter to cool 15–20 seconds between starting attempts or damage to the starter motor may occur.*

4. Allow the engine and hydraulic system to warm up for three to five minutes.

**WARNING:** Engine emits toxic gases. Severe respiratory damage or asphyxiation can result. Provide adequate ventilation. Consult with your regulatory authorities for exposure limits. Keep engine properly tuned.

5. Turn on lights.

### TURNING OFF THE MACHINE

1. Stop the machine and turn off all scrubbing functions.
2. Turn the ignition switch key counter clockwise to turn off the machine. Remain in the operator seat until the engine is off.

**FOR SAFETY: Before leaving or servicing machine, do not park near combustible materials, dust, gases, or liquids. Stop on level surface, set parking brake, turn off machine, and remove key.**

**FILLING THE SOLUTION TANK**

**FOAM SCRUBBING (FaST MODE) / ec-H2O SCRUBBING (ec-H2O MODE)**

**FOR SAFETY: Before leaving or servicing machine, stop on level surface, set parking brake, turn off machine, and remove key.**

1. Open either the left or right solution tank fill cover.
2. Fill the solution tank with only clean COOL WATER (less than 21°C / 70°F). DO NOT use hot water or add any conventional floor cleaning detergents or FaST system failure may result.

**! WARNING: Flammable materials can cause an explosion or fire. Do not use flammable materials in tank(s).**

*NOTE: To install or change the FaST-PAK carton, see the REPLACING THE FaST-PAK CARTON section of the manual.*



*NOTE: Do not use the FaST or ec-H2O system when there are conventional cleaning detergents in the solution tank. Drain, rinse, and refill the solution tank with clear cool water before operating the FaST or ec-H2O system. Conventional cleaning detergents may cause a FaST or ec-H2O system failure.*

**CONVENTIONAL SCRUBBING MODE**

**FOR SAFETY: Before leaving or servicing machine, stop on level surface, set parking brake, turn off machine, and remove key.**

1. Open either the left or right solution tank fill cover.
2. Partially fill solution tank with water (not to exceed 60°C / 140°F). Pour the required amount of detergent into the solution tank. Fill the solution tank with water until the level is just below the indicator tab.

**! WARNING: Flammable materials can cause an explosion or fire. Do not use flammable materials in tank(s).**



**ATTENTION: For Conventional Scrubbing, only use recommended cleaning detergents. Machine damage due to improper detergent usage will void the manufacturer's warranty.**

*NOTE: Pour a recommended foam control solution into the recovery tank if excessive foam appears. For specific detergent recommendations, contact a TENNANT representative.*

## OPERATION

### ES (EXTENDED SCRUB) MODE WITH AUTO-FILL

**FOR SAFETY:** Before leaving or servicing machine, stop on level surface, set parking brake, and turn off machine.

1. Connect the hose from the water source (not to exceed 60°C / 140°F) to the auto-fill connection.

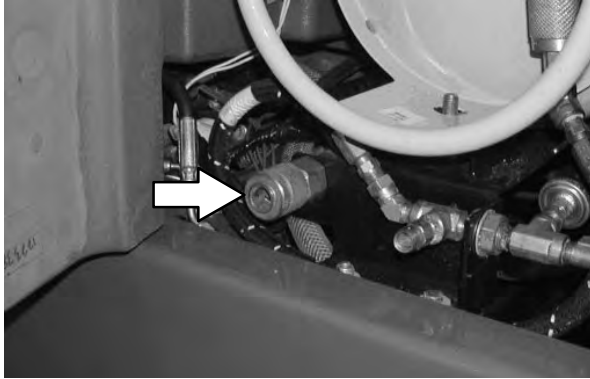

2. Turn the ignition switch to the on position (without starting) and turn on the water source. The auto-fill automatically fills the tanks to the proper level.
3. Fill the detergent tank with the proper detergent.

**WARNING:** Flammable materials can cause an explosion or fire. Do not use flammable materials in tank(s).

**ATTENTION:** For ES Scrubbing, only use recommended low-foaming cleaning detergents. Machine damage due to the use of improper detergent will void the manufacturer's warranty.

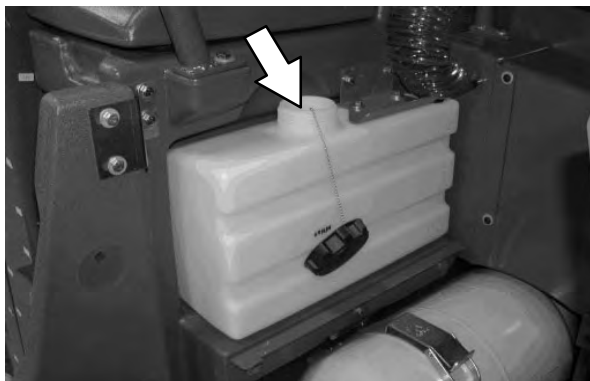

### ES (EXTENDED SCRUB) MODE – MANUALLY FILLING TANK

**FOR SAFETY:** Before leaving or servicing machine, stop on level surface, set parking brake, and turn off machine.

1. Open either the left or right solution tank cover and fill the solution tank with water (not to exceed 60°C / 140°F) until the level is just below the indicator tab.



2. Open the recovery tank cover and fill the recovery tank with water (not to exceed 60°C / 140°F) until the recovery tank is approximately half full.

**WARNING:** Flammable materials can cause an explosion or fire. Do not use flammable materials in tank(s).

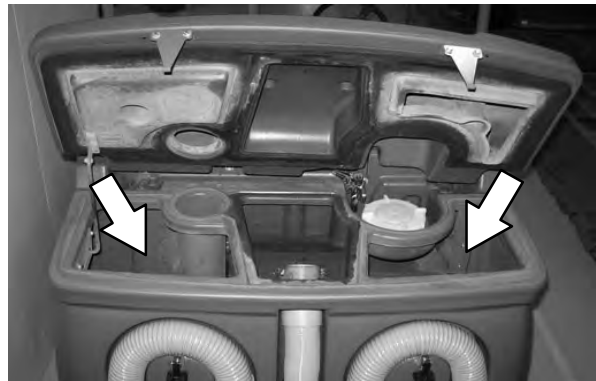

**SETTING SCRUB MODES**

Before scrubbing, determine which scrub mode will be used (FaST, ES, ec-H2O or conventional). Then set the scrub brush pressure and adjust the solution flow levels. The machine will default to the last setting used when it is powered on or off.

**SETTING ec-H2O MODE**

*NOTE: Storage or transporting machines equipped with ec-H2O in freezing temperatures requires special procedures. Follow the freeze protection procedure located in the STORAGE INFORMATION section.*

**Machines equipped with standard control panel:** The ec-H2O button enables the ec-H2O system to come on when the 1-STEP button is activated. The light above the button will come on.

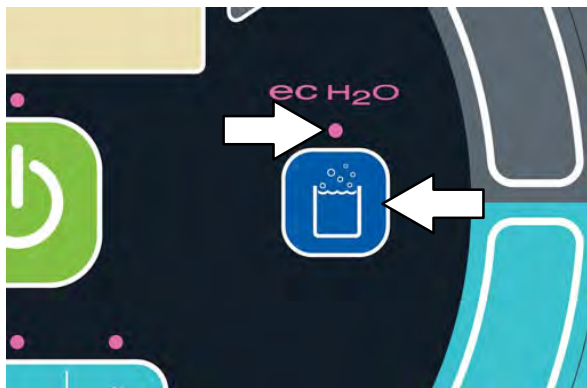

**Standard Panel**

A flashing red light located on the bottom portion of the LED (light-emitting diode) light directly above the ec-H2O button indicates when the ec-H2O system needs to be flushed. See ec-H2O MODULE FLUSH PROCEDURE in the MAINTENANCE section

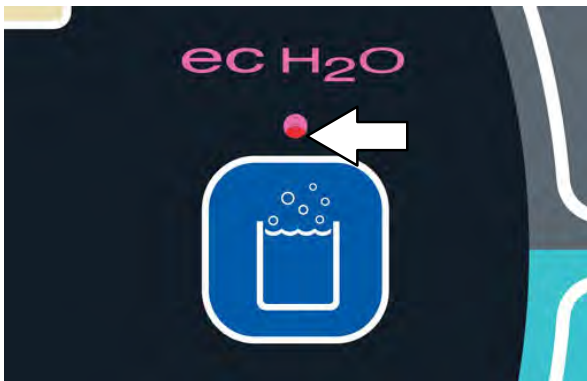

**Standard Panel**

**Machines equipped with Pro-Panel controls:** The background will change from black to the multicolored background, the slash disappears from the ec-H2O button, and the button is illuminated when the ec-H2O button is pushed to indicate it is active.

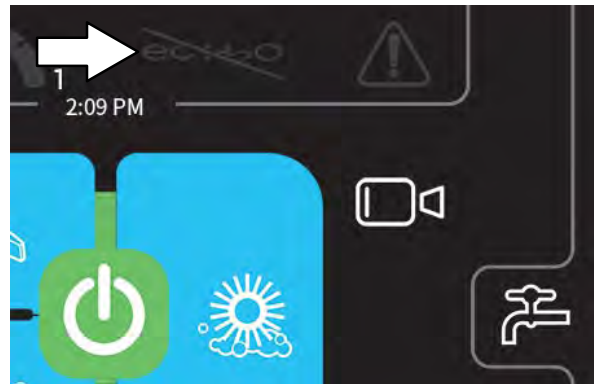

**Pro-Panel**

The ec-H2O button will turn red, the fault / alert indicator button will flash, and an ec-H2O error message will appear in the display when there is an ec-H2O error.

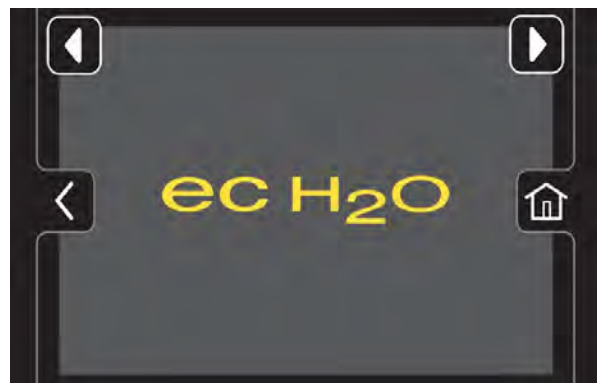

## OPERATION

### SETTING FaST MODE

**Machines equipped with standard control panel:** The *FaST* button enables the FaST system to come on when the *1-STEP* button is activated. The light next to the button will come on.



Standard Panel

**Machines equipped with Pro-Panel controls:** The slash disappears from the *ec-H2O* button and the button is illuminated when the *ec-H2O* button is pushed to indicate it is active.

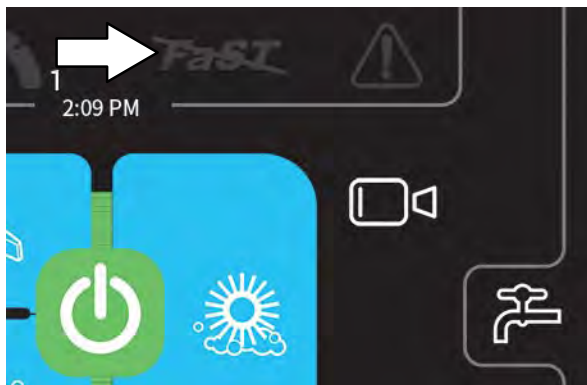

Pro-Panel

### SETTING ES (EXTENDED SCRUB) MODE

*NOTE: When the ES system is turned on there is a slight delay before the ES pump begins operating.*

**Machines equipped with standard control panel:** The *ES* button enables the ES system to come on when the *1-STEP* button is activated. The light next to the button will come on.

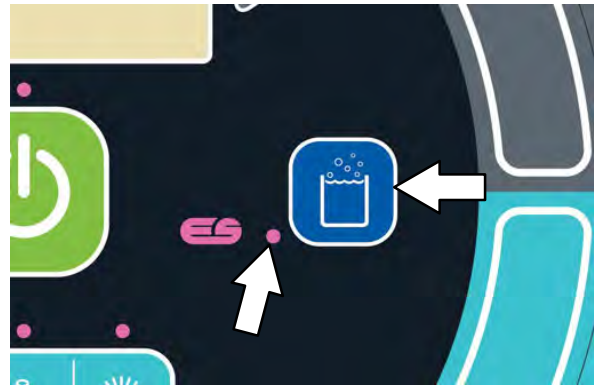

Standard Panel

**Machines equipped with Pro-Panel controls:** The slash disappears from the *ES* button and the button is illuminated when the *ES* button is pushed to indicate it is active.

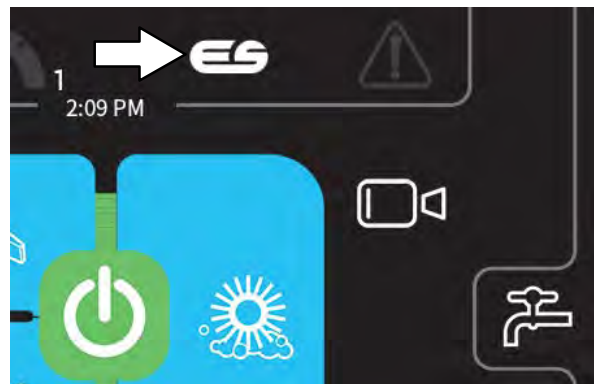
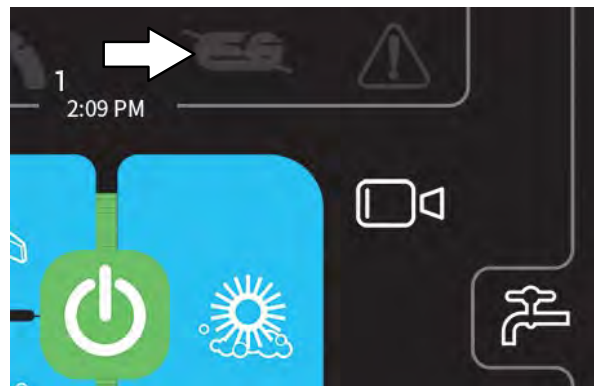

Pro-Panel

## SETTING BRUSH PRESSURE

Under normal cleaning conditions, the brush pressure should be set to the lowest setting. Under heavy grime conditions, the brush pressure can be set to a higher setting. Travel speed and floor conditions will affect cleaning performance. If brushes are worn, it may be necessary to increase the brush pressure. The machine will default to the last setting used when it is powered on or off.

### SETTING BRUSH PRESSURE – STANDARD PANEL

With the *1-STEP* button activated, press the *brush pressure* button to both raise or lower the brush pressure settings. The brush pressure indicator lights display the current brush pressure setting.



### SETTING BRUSH PRESSURE – PRO-PANEL

Press the *brush pressure* button to access the *brush pressure increase (+)* button, the *brush pressure decrease (-)* button, and the *brush pressure indicator bar*.



Use the *brush pressure increase (+)* button and the *brush pressure decrease (-)* button to change the brush pressure. The *brush pressure indicator bar* displays the current brush pressure setting.



# OPERATION

## SETTING SOLUTION FLOW

Travel speed and floor conditions will affect scrubbing performance. Under normal soilage conditions the solution flow level should be set to the lowest setting. Under heavy grime conditions, the solution flow level should be set to the higher settings. The machine will default to the last setting used when the machine is powered on or off.

### ES (EXTENDED SCRUB) SOLUTION FLOW

**For ES machines, the detergent flow is turned off when the solution flow is in the lowest setting.** Under normal soilage conditions, the solution flow level should be alternated between the middle and lowest setting. The middle setting allows solution AND detergent flow. The lowest setting allows solution flow WITHOUT adding detergent. Detergent does not have to be continuously added with the solution flow to attain effective scrubbing results.

### SETTING SOLUTION FLOW – STANDARD PANEL

With the 1-STEP button activated, press either solution increase (+) button or solution decrease (-) button to set the solution flow level. The solution flow indicator lights display the current solution flow setting.

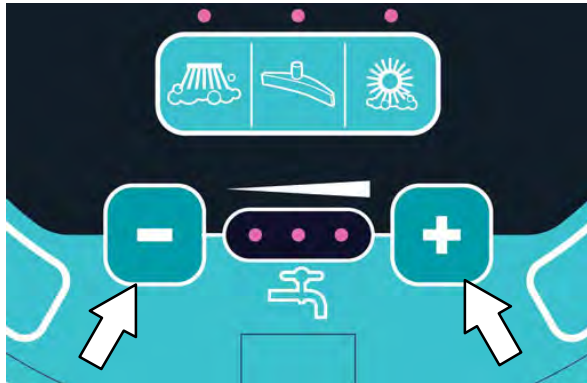

### SETTING SOLUTION FLOW – PRO-PANEL

Press the solution flow button to access the solution increase (+) button, the solution decrease (-) button, and the solution flow indicator bar.



Use the solution increase (+) button and the solution decrease (-) button to set the solution flow level. The solution flow indicator bar displays the current solution flow setting.



## SCRUBBING – STANDARD PANEL

The *1-STEP* button operates all the scrubbing functions.

**FOR SAFETY: Do not operate machine, unless operator manual is read and understood.**

1. Start the machine.

*NOTE: Make sure the scrub modes / settings are set before scrubbing.*

2. Press the *1-STEP* button. The light above the button will come on. All the preset scrubbing functions will turn on.

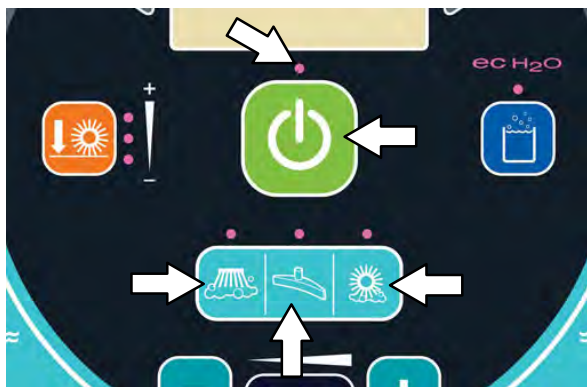

*NOTE: DO NOT turn on the FaST or ec-H2O system during conventional scrubbing. Conventional cleaning detergents could cause a FaST or ec-H2O system failure. Drain, rinse, and refill the solution tank with cool clean water before operating the FaST or ec-H2O system.*

3. Release the parking brake, then press the *Directional pedal* to begin scrubbing.

**WARNING:** Flammable materials or reactive metals can cause an explosion or fire. Do not pick up.

**FOR SAFETY: When using machine, go slow on inclines and slippery surfaces.**

*NOTE: The squeegee automatically rises when the machine is driven backwards. This prevents damaging the squeegee.*

4. Release the *directional pedal* and press the *brake pedal* to stop the machine.
5. Press the *1-STEP* button to stop scrubbing. The light above the button will go off and the scrubbing functions will stop after a short delay.



*NOTE: If there is a fault or alert code during machine operation, stop the machine and refer to the FAULTS / ALERTS section of this manual for the cause and the corrective action for eliminating the fault or alert.*

6. Empty the recovery tank at the end of each shift or as needed. See *DRAINING AND CLEANING THE RECOVERY TANK* sections of this manual.

# OPERATION

## SCRUBBING – PRO-PANEL

The 1-STEP button operates all the scrubbing functions.

**FOR SAFETY: Do not operate machine, unless operator manual is read and understood.**

1. Start the machine.
2. If applicable, log into the machine. See *PRO-ID LOGIN SCREEN*.
3. If applicable, complete the Pro-Check Pre-Operation Checklist. See *COMPLETING THE PRO-CHECK PRE-OPERATION CHECKLIST*.

*NOTE: Make sure the scrubbing modes / settings are set before scrubbing.*

4. Press the 1-STEP button. The 1-STEP button and all other selected scrubbing buttons will illuminate.

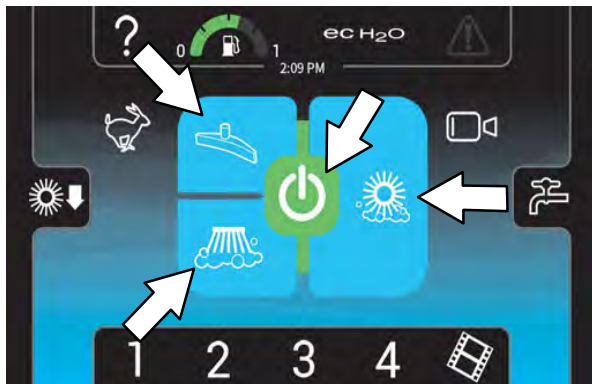

*NOTE: DO NOT turn on the FaST or ec-H2O system during conventional scrubbing. Conventional cleaning detergents could cause a FaST or ec-H2O system failure. Drain, rinse, and refill the solution tank with cool clean water before operating the FaST or ec-H2O system.*

5. Release the parking brake, then press the *Directional pedal* to begin scrubbing.

**WARNING:** Flammable materials or reactive metals can cause an explosion or fire. Do not pick up.

**FOR SAFETY: When using machine, go slow on inclines and slippery surfaces.**

*NOTE: The squeegee automatically rises when the machine is driven backwards. This prevents damaging the squeegee.*

6. Press the *rearview camera button* at any time to check cleaning performance behind the machine.



7. Release the *directional pedal* and press the *brake pedal* to stop the machine.

*NOTE: If there is a fault or alert code during machine operation, stop the machine and refer to the **FAULTS / ALERTS** section of this manual for the cause and the corrective action for eliminating the fault or alert.*

8. Empty the recovery tank at the end of each shift or as needed. See *DRAINING AND CLEANING THE RECOVERY TANK* sections of this manual.

**DOUBLE SCRUBBING**

Double scrubbing is the process of making two or more passes over a heavily soiled area. The first pass is made with the rear and side squeegees raised to allow the solution to soak into the floor. Use the double scrubbing method to clean heavily soiled areas.

Double scrubbing can be performed using the FaST SCRUBBING SYSTEM (option), ec-H<sub>2</sub>O SCRUBBING SYSTEM (option) or CONVENTIONAL SCRUBBING methods.

Side brush option: Before double scrubbing, remove the side brush bumper. Pull the pins and remove the squeegee bumper.

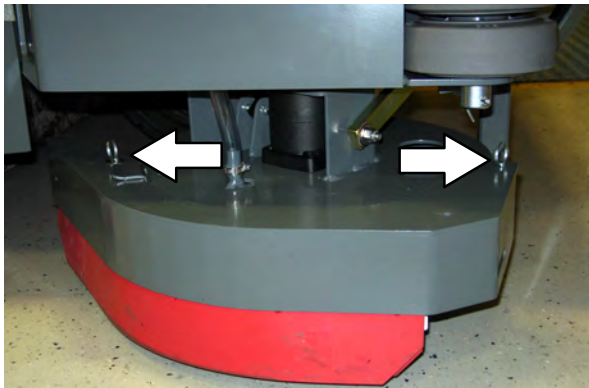

*NOTE: Make sure the scrubbing modes / settings are set before scrubbing.*

**Machines equipped with standard panel:** Press the 1-STEP button, and then the Scrub vacuum fan/squeegee button. The light above the Scrub vacuum fan/squeegee button will turn off, the squeegee will rise, and the vacuum fan will stop operating. Scrub the heavily soiled area.

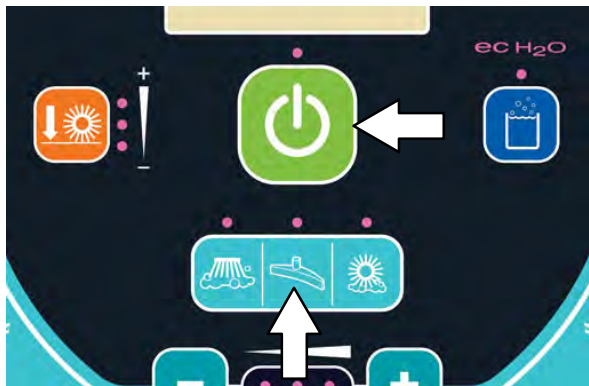

**Standard Panel**

*NOTE: Make sure the scrubbing modes / settings are set before scrubbing.*

**Machines equipped with Pro-Panel:** Press the 1-STEP button and then the vacuum fan / squeegee button. The vacuum fan / squeegee button will no longer be illuminated, the squeegee will rise, and the vacuum fan will stop operating. Scrub the heavily soiled area.



**Pro-Panel**

Let the cleaning solution soak on the floor for 5-15 minutes. Reinstall the side brush squeegee bumper onto the side brush.

**FOR SAFETY: When using machine, go slow on inclines and slippery surfaces.**

Press the Scrub vacuum fan/squeegee button again to lower the squeegee and turn on the vacuum fan. Scrub the floor a second time to pick up the cleaning solution.

**! WARNING: Flammable materials or reactive metals can cause an explosion or fire. Do not pick up.**

*NOTE: If needed, reduce solution flow when scrubbing the floor for a second time.*

*NOTE: Double scrubbing is not recommended in areas where the cleaning solution will run under racks or damage products.*

## WATER PICKUP MODE (NO SCRUBBING)

The machine can be used to pick up water or non-flammable liquid spills without scrubbing.

**WARNING:** Flammable materials or reactive metals can cause an explosion or fire. Do not pick up.

Before picking up water or non-flammable liquid spills, make sure the *1-STEP* button is activated and all other cleaning functions are off.

**Machines equipped with standard control panel:** Press the *scrubbing vacuum fan / squeegee* button. The light above the button will illuminate, the squeegee will lower, and the vacuum fan will start operating. Pick up the water or non-flammable liquid spill.



Standard Panel

**Machines equipped with Pro-Panel controls:** Press the *scrubbing vacuum fan / squeegee* button. The button will illuminate, the squeegee will lower, and the vacuum fan will start operating. Pick up the water or non-flammable liquid spill.



Pro-Panel

**EMPTYING AND CLEANING THE DEBRIS TRAY – CYLINDRICAL SCRUB HEADS ONLY**

1. Drive the machine to a debris dump site.

**FOR SAFETY: Before leaving or servicing machine, stop on level surface, set parking brake, turn off machine, and remove key.**

2. Press the debris tray carriage release lever.



3. Pull the debris tray carriage open.

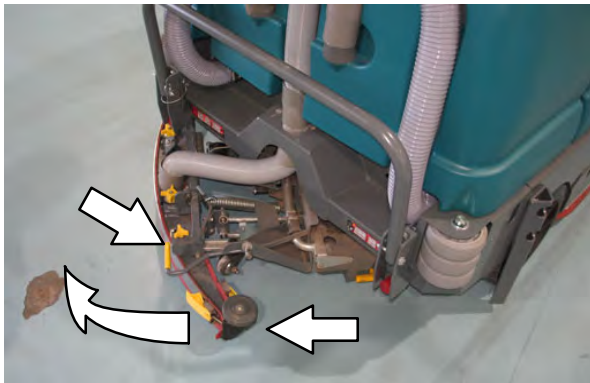

4. Pull the debris tray from the carriage.

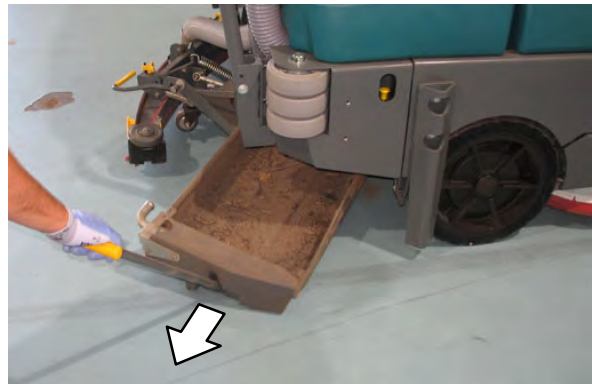

5. Empty the contents from the debris tray.

6. Remove the debris screen from the debris tray.

7. Rinse the debris screen and the debris tray.



## OPERATION

8. Disconnect the vacuum hose from the rear coupling.



9. Spray water through the port located inside the vacuum coupling to rinse debris from the debris tray coupling.

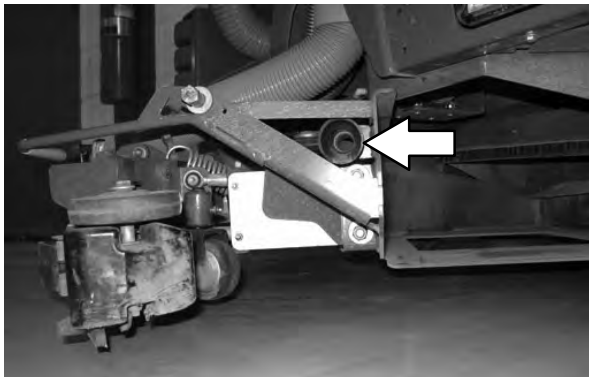

10. Reconnect the vacuum hose to the rear coupling.

11. Reinstall the debris screen into the debris tray.

12. Align the debris tray with the debris tray carriage, use the handle to guide the debris tray into the debris tray carriage, and slide the handle back into the debris tray.

13. Lift slightly on the debris tray carriage handle and push the debris tray carriage closed until it locks shut.

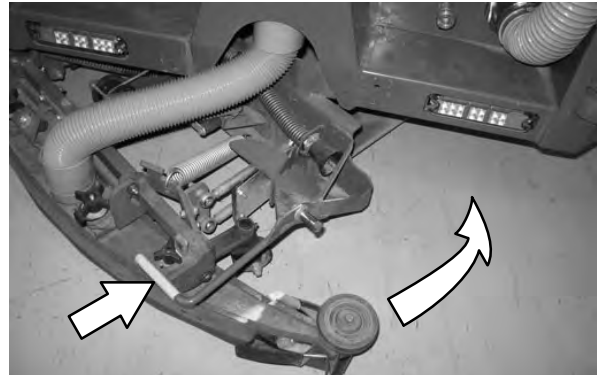

**DRAINING AND CLEANING THE RECOVERY TANK**

Drain and clean the recovery tank daily or when the recovery tank full indicator comes on.

Clean the outside of the recovery tank with vinyl cleaner.

**FOR SAFETY: Before leaving or servicing machine, stop on level surface, set parking brake, turn off machine, and remove key.**

**DRAINING THE RECOVERY TANK WITH THE DRAIN HOSE**

1. Lift the recovery tank cover.



2. Place the recovery tank drain hose nozzle next to a floor drain.

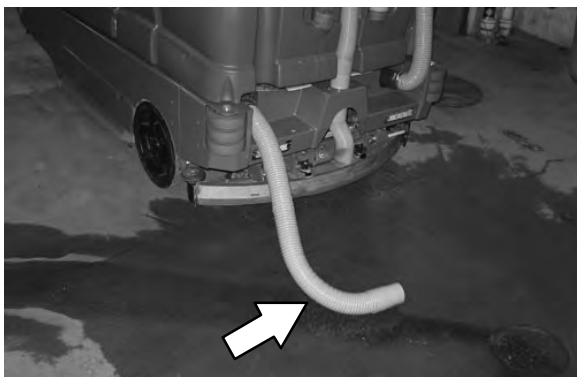

3. Open the recovery tank Variable Drain Valve.

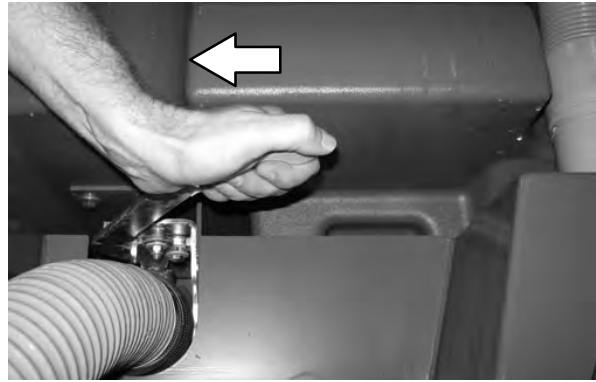

4. Rinse dirt and debris down through the drain hole in the demister tray and flush the vacuum hose.

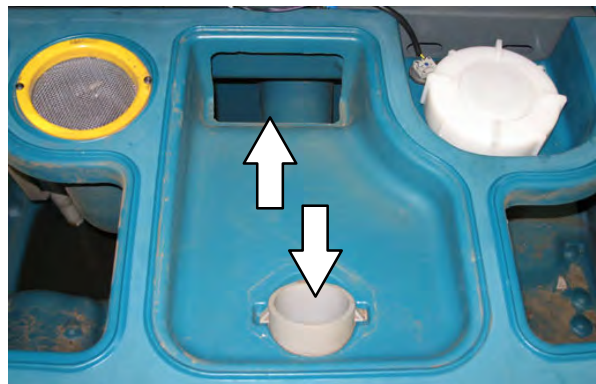

*NOTE: DO NOT use steam to clean tanks. Excessive heat can damage tanks and components.*

5. Remove the vacuum screen from the recovery tank and rinse the screen.

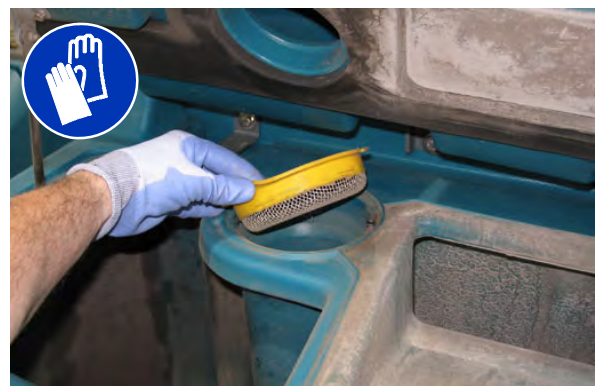

## OPERATION

6. Rinse the float sensor.

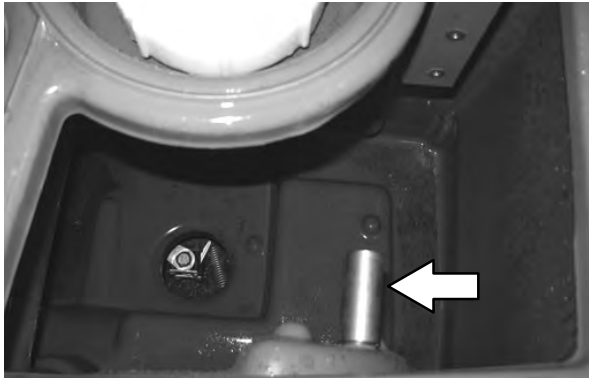

7. ES machines: Rinse the ES filter. If necessary, remove the ES filter from the recovery tank.

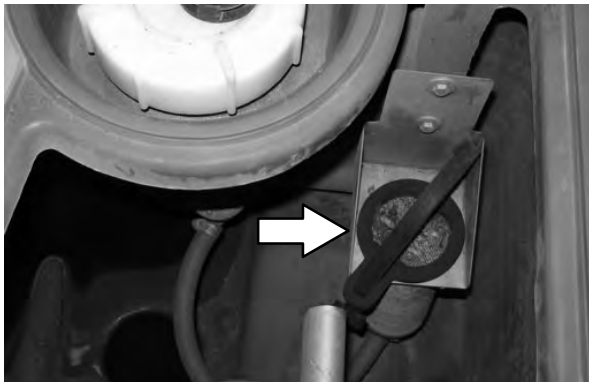

8. Rinse dirt and debris towards the recovery tank drain. Allow the recovery tank to drain.

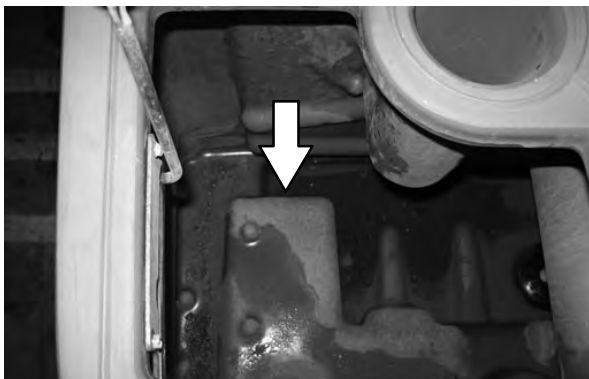

9. Close the recovery tank Variable Drain Valve.

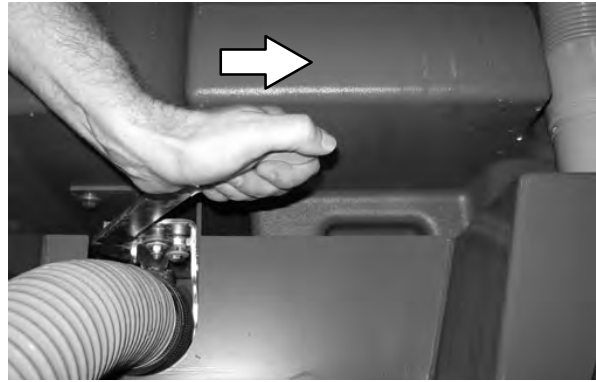

10. Reinstall the recovery tank drain hose onto the back of the recovery tank and close the recovery tank cover.

### DRAINING THE RECOVERY TANK WITH THE DRAIN PLUG

Use the drain plug to drain the recovery tank if the tank is draining slowly or if the drain hose is plugged.

1. Park the machine so the larger drain in the recovery tank is positioned over the disposal drain. Set the parking brake.

**FOR SAFETY: Before leaving or servicing machine, stop on level surface, set parking brake, turn off machine, and remove key.**

2. **Machines equipped with cylindrical scrub heads only:** To avoid water and debris from getting in the debris tray, open the debris carriage and remove the debris tray.



3. Lift the drain plug handle and remove the drain plug from the tank.



4. Open the recovery tank Variable Drain Valve.



5. Remove the recovery tank drain hose from the back of the recovery tank, then rinse the dirt and debris from the hose into the tank.



6. Rinse dirt and debris out the open drain.

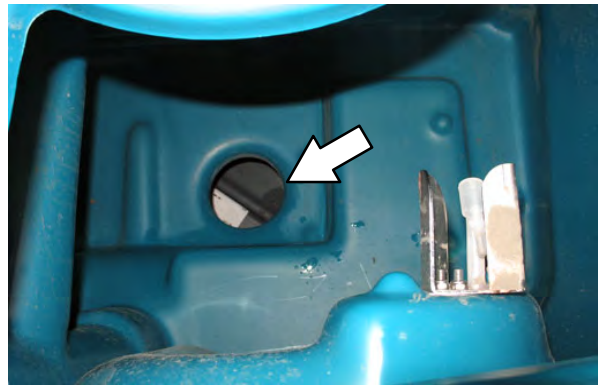

7. Clean the drain hole, then reinsert the drain plug. Push the handle down to tighten. Be sure the drain plug is fully seated before tightening.

*NOTE: If necessary, turn the handle clockwise for a tighter fit and counterclockwise for a looser fit.*



## OPERATION

8. Close the recovery tank Variable Drain Valve.

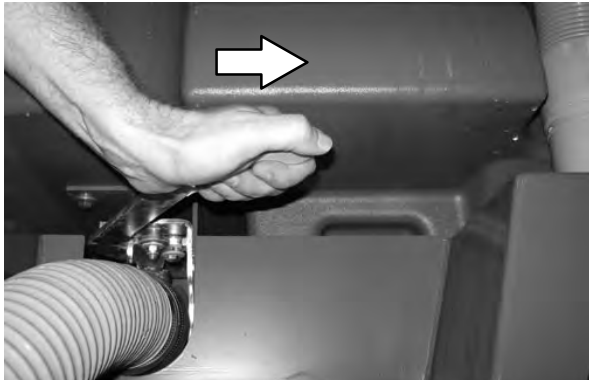

9. Reinstall the recovery tank drain hose onto the back of the recovery tank.
10. **Machines equipped with cylindrical scrub heads only:** Reinstall the debris tray into the debris tray carriage and close the carriage.
11. Close the recovery tank cover.

## DRAINING AND CLEANING THE SOLUTION TANK

The solution tank on non-ES machines does not require regular maintenance. If deposits form on the bottom of the tank, rinse the tank with a strong blast of warm water.

The solution tank on machines with the ES option should be drained and cleaned daily.

Clean the outside of the solution tank with vinyl cleaner.

**FOR SAFETY: Before leaving or servicing machine, stop on level surface, set parking brake, turn off machine, and remove key.**

1. Open the solution tank cover(s).



2. Place the solution tank drain hose nozzle next to a floor drain.

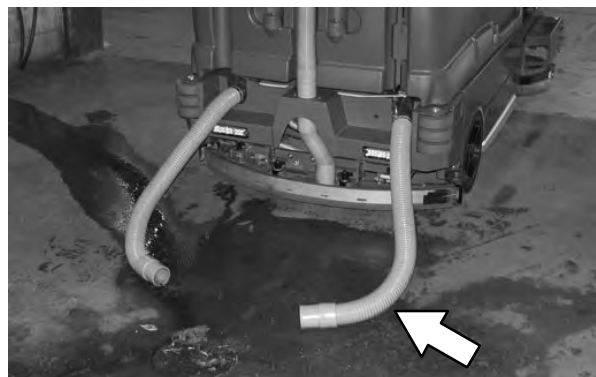

3. Open the solution tank Variable Drain Valve.

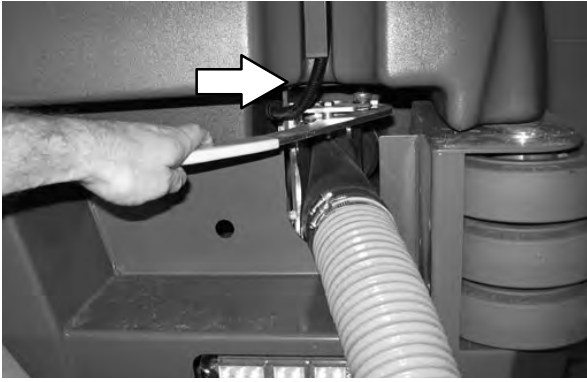

6. Close the solution tank Variable Drain Valve.

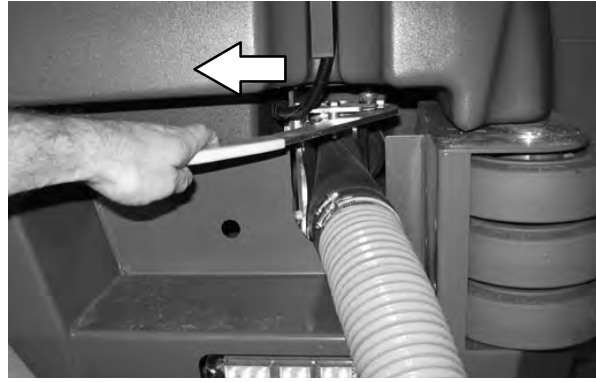

4. Rinse the solution tank. Flush dirt and debris toward the solution tank drain.

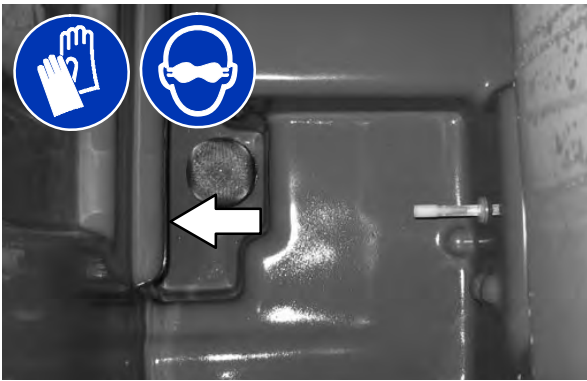

7. Reinstall the solution tank drain hose onto the back of the recovery tank.

8. Close the solution tank cover(s).

5. Rinse the float sensor and the screen filter. Allow the solution tank to drain.

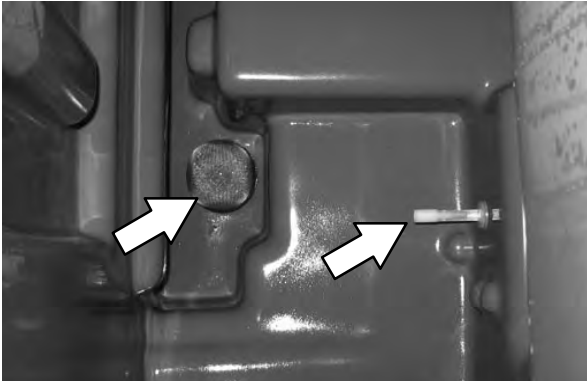

# OPERATION

## FAULTS / ALERTS

The operator will receive a fault / alert warning when there is a mechanical / electronic issue with the machine.

To reset the fault / alert indicators, turn off the machine and then eliminate the cause of the fault / alert. The fault / alert indicator will reset when the machine is restarted.

Refer to the fault / alert indicators table to determine the cause and remedy for the fault / alert.

*NOTE: When the machine is turned on without the engine running, the low engine oil pressure, low alternator voltage and check engine lamp faults will appear. This is normal behavior.*

## FAULT / ALERT INDICATORS – STANDARD PANEL

This machine is equipped with two visual indicators, a red indicator light and an LCD (liquid crystal display).

The red indicator light will blink continuously indicating that a fault / alert has occurred.

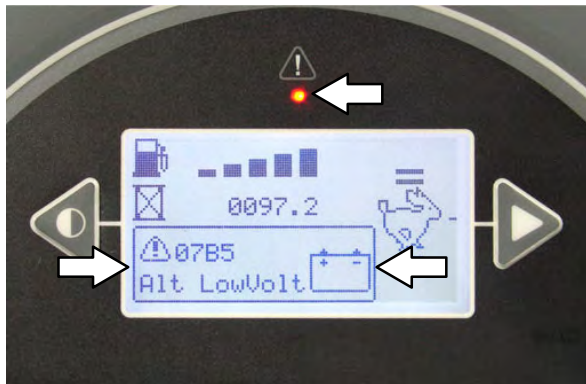



The LCD will display a fault / alert code. If there is more than one fault, each fault code will alternately display.

## FAULT / ALERT INDICATORS – PRO-PANEL

The *fault / alert indicator button* will flash continuously indicating a fault / alert has occurred. The multicolored background will change to a black background.





 Press the flashing *red fault indicator button* to view the faults. A fault / alert screen will appear in the display.

 Press the flashing *yellow alert indicator button* to view the alerts. A fault / alert screen will appear in the display.

Fault / alert text will appear under the icon in the center of the screen



 Press *right arrow button* to scroll forward through the faults / alerts.

 Press *left arrow button* to scroll back through the faults / alerts.

 Press the *home button* to return to the main operating screen.

 Press the *back button* to return to the previous screen.

<b>Fault Code Number</b>	<b>Fault Code Standard Panel</b>	<b>Fault Code Pro-Panel</b>	<b>Causes(s)</b>	<b>Remedy</b>
0x0010	Fault Parking Brake	Fault Parking Brake	Parking brake engaged	Release parking brake
0x0701	Fault ECH2O Flush Needed	Fault ECH2O Flush Needed	ec-H2O system plugged with impurities	Flush ec-H2O system
0x0781	Fault Detergent Empty	Fault Detergent Empty	Detergent tank is empty	Fill detergent tank
0x0790	Fault Solution Tank Empty	Fault Solution Tank Empty	Solution tank is empty	Fill solution tank
0x0791	Fault Recovery Tank Full	Fault Recovery Tank Full	Recovery tank is full	Empty recovery tank
0x07A0	Fault Filter Clogged	Fault Filter Clogged	Hydraulic filter clogged	Shut off machine. Contact TENNANT service representative
0x07A2	Fault Hopper Not Home	Fault Hopper Not Home	Hopper not completely lowered	Lower hopper completely
0x07A4	Fault Seat Empty	Fault Seat Empty	Operator not in seat while engine is running	Operator must be in operator seat for machine to function
0x07B0	Fault Engine High Temp	Fault Engine High Temp	Engine overheating	Add coolant to coolant system
0x07B1	Fault Hydraulic High Temp	Fault Hydraulic High Temp	Hydraulic fluid temperature is high	Shut off machine. Contact TENNANT service representative
0x07B2	Fault Engine Malfunction Indicator	Fault Engine Malfunction Indicator	Engine malfunction	Shut off machine. Contact TENNANT service representative
0x07B3	Fault Low Fuel	Fault Low Fuel	Fuel tank near empty	Fill fuel tank (gasoline) Replace fuel tank (LPG)
0x07B4	Fault Engine Low Oil Pressure	Fault Engine Low Oil Pressure	Oil level possibly low	Add engine oil as needed
0x07B5	Fault Engine Alternator Low Voltage	Fault Engine Alternator Low Voltage	Inadequate voltage supply to engine	Shut off machine. Contact TENNANT service representative

*\*NOTE: Contact a Tennant Service representative for all other fault codes.*

# OPERATION

## OPTIONS

### SPRAY NOZZLE (OPTION)

The spray nozzle is used to clean the machine and surrounding areas. The solution tank provides a water/solution supply for the spray nozzle. A wand is included with the spray nozzle.

*NOTE: Do NOT get water on electronic components when using the spray nozzle to clean the machine.*

**FOR SAFETY: Before leaving or servicing machine, stop on level surface, set parking brake, and turn off machine.**

1. Turn the key to the on position (without starting the machine).

*NOTE: The spray nozzle can be operated while the engine is running, but it is recommended to turn the engine off while using the spray nozzle.*

2. Press the top of the *Spray nozzle switch* to turn on the water supply. The light on the switch will come on when the spray nozzle is activated.



3. Remove the spray nozzle from the storage area and clean as required.

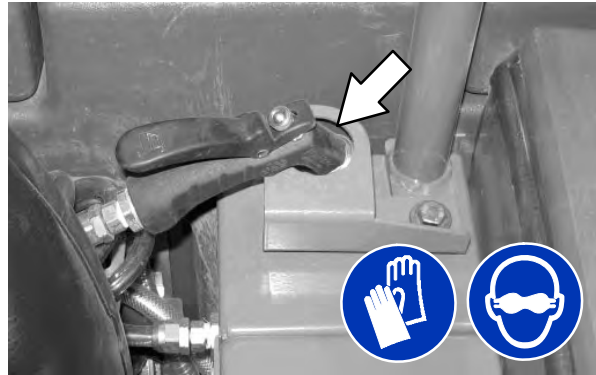

**FOR SAFETY: When using pressurized air or water, wear eye protection.**

4. If cleaning a hard to reach area, install the wand onto the spray nozzle.



5. Twist the off/on knob to turn on the wand.

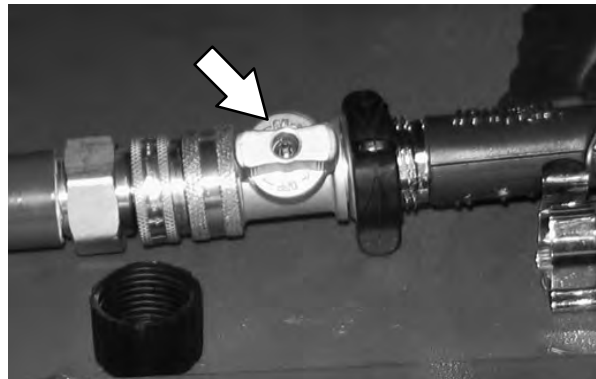

6. When finished cleaning, place the spray nozzle and wand back into their storage locations.

7. Press the bottom of the *Spray nozzle switch* to turn off the water supply.

### DETERGENT METERING (OPTION)

The *Detergent Metering switch* provides a continuous increased detergent flow for areas with extraordinary dirt or soil buildup. The detergent tank provides the detergent for the detergent metering switch.

Fill the detergent tank with proper detergent.

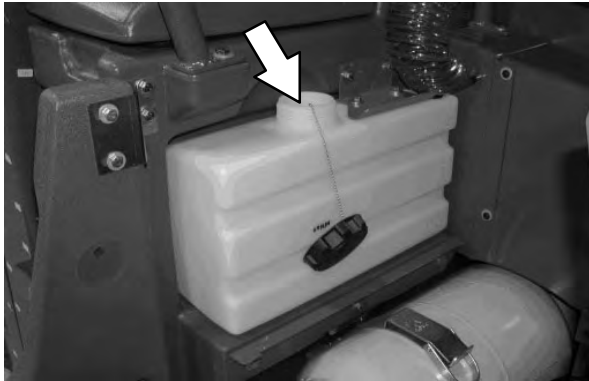

While scrubbing, press the top of the switch to increase detergent flow. Press the bottom of the switch for even more increased detergent flow. The light in the switch display which setting is activated.



**NOTE:** The switch can be configured to allow different flow rates. Contact a Tennant service representative to change the default flow rates.

## OPERATION

### VACUUM WAND (OPTION)

**FOR SAFETY: Before leaving or servicing machine, stop on level surface, set parking brake, turn off machine, and remove key.**

1. Remove the vacuum wand sections and hose from the storage bag located on top the recovery tank cover.
2. Disconnect the vacuum hose from the rear coupling and attach the wand hose.



3. Assemble the wand and nozzle.



4. Start the machine.

**WARNING: Engine emits toxic gases. Severe respiratory damage or asphyxiation can result. Provide adequate ventilation. Consult with your regulatory authorities for exposure limits. Keep engine properly tuned.**

5. Verify that the *1-STEP* button is on.
6. Press the *vacuum fan / squeegee* button to turn on the vacuum fan.

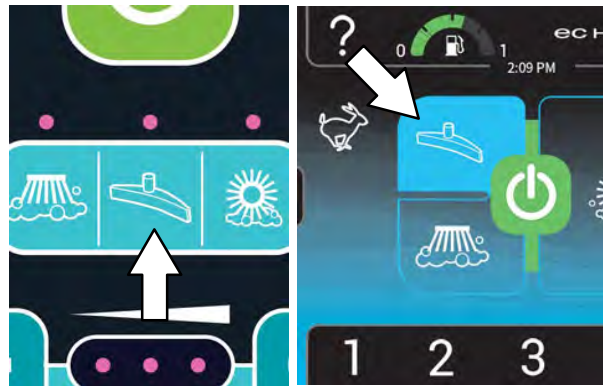

Standard Panel

Pro-Panel

*NOTE: The squeegee will lower.*

7. Clean the spill or debris.



8. When finished vacuuming, press the *Scrub vacuum fan/squeegee* button to turn off the vacuum. The light above the button will turn off.
9. Turn off the machine.
10. Disassemble the vacuum wand assembly and return it to the storage bag.
11. Reattach the vacuum hose to the rear coupling.

## POWER WAND (OPTION)

The power wand uses both the vacuum and solution systems. The power wand allows the user to scrub floors that are out of reach of the machine.

**FOR SAFETY: Before leaving or servicing machine, stop on level surface, set parking brake, turn off machine, and remove key.**

1. Remove the power wand equipment from the storage bag on top the recovery tank cover.
2. Remove the squeegee suction hose from the top of the rear squeegee assembly.
3. Connect the vacuum wand hose and the squeegee vacuum hose with the adapter.

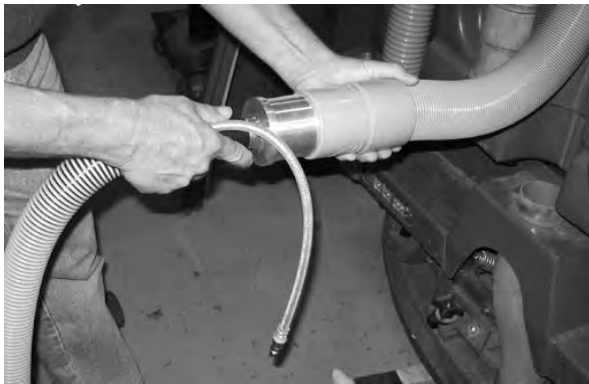

4. Attach the solution hose to the quick-disconnect fitting. Push the connector in until it stops. Pull on the hose to ensure it is connected.



5. Attach the other ends of the solution and vacuum hoses to the power wand.



6. Start the machine.

**WARNING: Engine emits toxic gases. Severe respiratory damage or asphyxiation can result. Provide adequate ventilation. Consult with your regulatory authorities for exposure limits. Keep engine properly tuned.**

7. Verify that the 1-STEP button is on.
8. Press the vacuum fan / squeegee button. The vacuum fan will start operating.

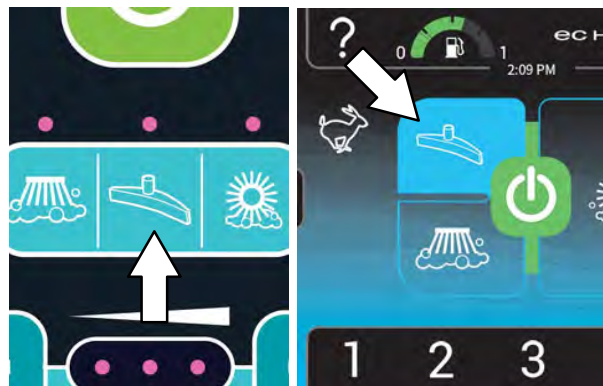

Standard Panel

Pro-Panel

*NOTE: The squeegee will also lower.*

## OPERATION

9. Press the top of the *Spray nozzle switch* to turn on the water supply.



10. Squeeze the solution lever on the power wand to spray solution onto the floor. Scrub the floor with the brush side of the cleaning tool.

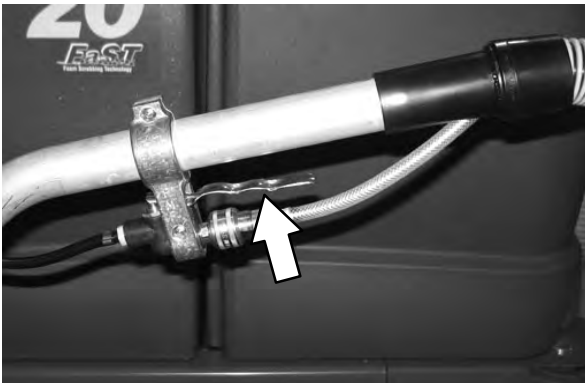

11. Vacuum up the solution by turning over the cleaning tool so the squeegee side is down.



If the cleaning tool is hard to push or is not picking up the solution very well, adjust the roller wheels on the tool by turning the black adjustment knob.

*NOTE: The wheels are properly adjusted when the squeegee blade deflects slightly while the cleaning tool is pushed back and forth.*

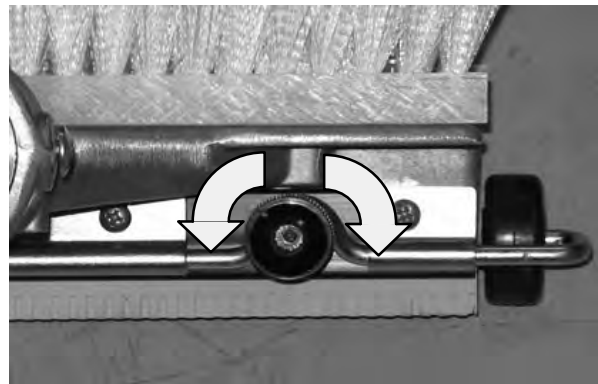

12. When finished scrubbing, press the *vacuum fan/squeegee button* to turn off the vacuum and press the bottom of the *Spray nozzle switch* to turn off the water supply.

13. Turn off the machine.

14. Disconnect the power wand vacuum hose from the squeegee suction hose and the solution hose from the quick-disconnect fitting.

15. Reconnect the vacuum hose to the rear squeegee assembly.

16. Disassemble the power wand assembly and return it to the storage bag.

**HIGH PRESSURE WASHER (OPTION)**

The high pressure washer is used for heavy duty cleaning. Do not use detergent in the solution tank when using the pressure washer or pressure washer damage could occur.

*NOTE: Do NOT get water on electronic components when using the high pressure washer to clean the machine.*

**FOR SAFETY: Before leaving or servicing machine, stop on level surface, set parking brake, and turn off machine.**

**FOR SAFETY: When using pressurized air or water, wear eye and ear protection.**

1. Turn off the machine and set the parking brake.

*NOTE: The high pressure washer will not operate unless the parking brake is set.*

2. Connect the hose to the high pressure washer system.

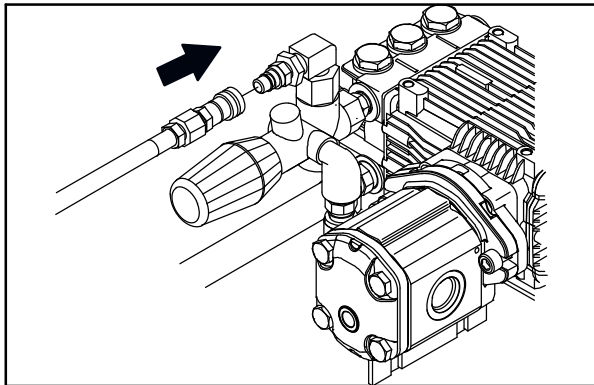

3. Connect the other end of the hose to the wand.



4. Adjust the nozzle on the wand to the desired setting.

Pull the nozzle out for the **Low** pressure setting, or push the nozzle in for the **High** pressure setting. Twist the nozzle for either the **Stream** or **Fan** setting.



5. Start the machine.

**! WARNING: Engine emits toxic gases. Severe respiratory damage or asphyxiation can result. Provide adequate ventilation. Consult with your regulatory authorities for exposure limits. Keep engine properly tuned.**

## OPERATION

6. Verify that the 1-STEP button is off.

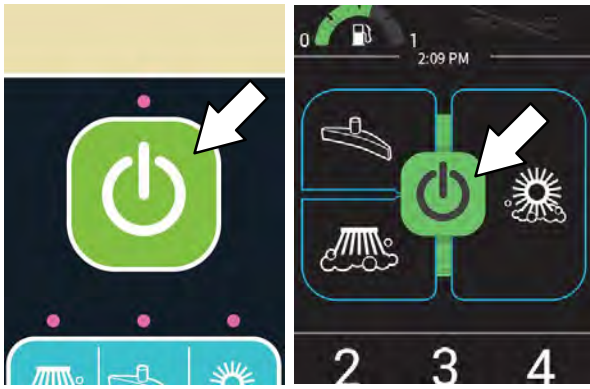

Standard Panel

Pro-Panel

7. Press the engine speed button to increase the engine RPM.

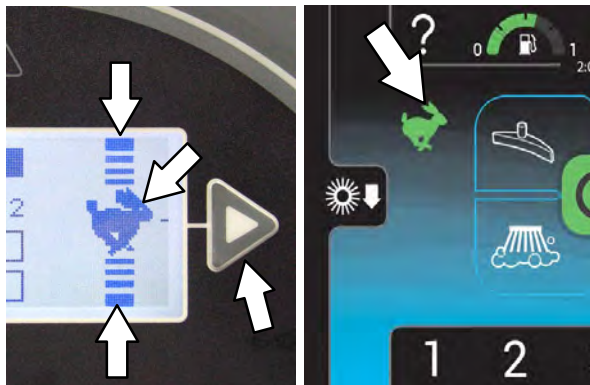

Standard Panel

Pro-Panel

8. Press the top of the Pressure washer switch.



9. If necessary, adjust the pressure. Turn the knob clockwise to increase pressure and counterclockwise to decrease pressure.

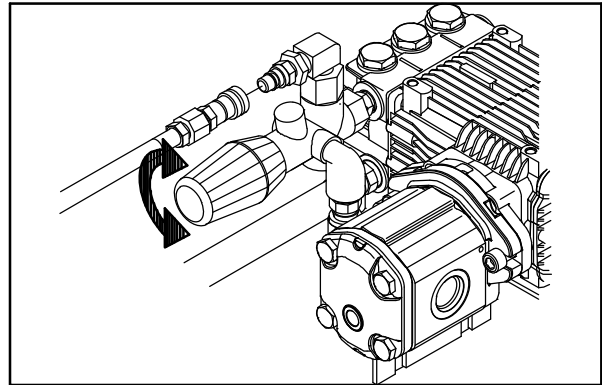

**NOTE:** Adjust the pressure at the wand before adjusting it at the system.

10. Squeeze the trigger to begin cleaning.

**WARNING:** Do not spray people or animals. Severe personal injury can result. Wear eye protection. Hold sprayer with two hands.



11. When finished cleaning, release the trigger.

12. Press the engine speed button to decrease the engine RPM.

13. Press the bottom of the Pressure washer switch to turn off the washer.

14. Point the high pressure wand in a safe direction and squeeze the trigger to relieve pressure from the system.

15. Turn off the machine.

16. Disassemble the hose and wand and return them to the proper storage locations.

**MACHINE TROUBLESHOOTING**

Problem	Cause	Remedy
Trailing water–poor or no water pickup	Scrub vacuum fan turned off	Turn on vacuum fan
	Worn squeegee blades	Rotate or replace squeegee blades
	Squeegee out of adjustment	Adjust squeegee
	No detergent in solution tank causing squeegee to chatter	Add detergent to solution tank
	Vacuum hose clogged	Flush vacuum hoses
	Vacuum screen dirty	Clean vacuum screen
	Recovery tank cover seals worn	Replace seals
	Debris caught in squeegee	Remove debris
	Vacuum hose to squeegee or recovery tank disconnected or damaged	Reconnect or replace vacuum hose
	Recovery tank cover not completely closed	Check for obstructions and make sure cover is closed properly
Scrub vacuum fan will not turn on	Vacuum fan / squeegee button turned off	Turn on Vacuum fan / squeegee button
	Recovery tank full	Drain recovery tank
	Foam filling recovery tank	Empty recovery tank
		Use less detergent/or use defoamer
Recovery tank sensor dirty or stuck	Clean or replace sensor	
Little or no solution flow to the floor (Conventional Scrubbing Mode)	Solution tank empty	Fill solution tank
	Solution flow turned off	Turn on solution flow
	Solution supply lines plugged	Flush solution supply lines
Poor scrubbing performance	<i>1-STEP button</i> not on	Turn on <i>1-STEP button</i>
	Improper detergent or brushes	Call Tennant service representative
	Solution tank empty	Fill solution tank
	Debris caught on main brushes	Remove debris
	Worn main brushes	Replace brushes
	Brush pressure set too light	Increase brush pressure

## OPERATION

Problem	Cause	Remedy
FaST System does not operate	FaST button is turned off	Turn on the FaST button
	Clogged FaST-PAK supply hose and/or connector	Soak connector and hose in warm water and clean
	FaST-PAK carton is empty or not connected	Replace FaST-PAK carton and/or connect supply hose
	FaST system is not primed	To prime, operate the FaST solution system for a few minutes
	Clogged filter screen	Drain solution tank, remove and clean filter screen
	Blown fuse	Call Tennant service representative
	Faulty solution pump	Call Tennant service representative
ES System does not operate	<i>ES button</i> is turned off	Turn on <i>ES button</i>
	ES sensor in tank dirty	Clean sensor
	Clogged ES pump filter	Clean ES filter
	Water level in recovery tank too low	Fill recovery tank about half full
	Water level in solution tank too low	Fill solution tank

MAINTENANCE

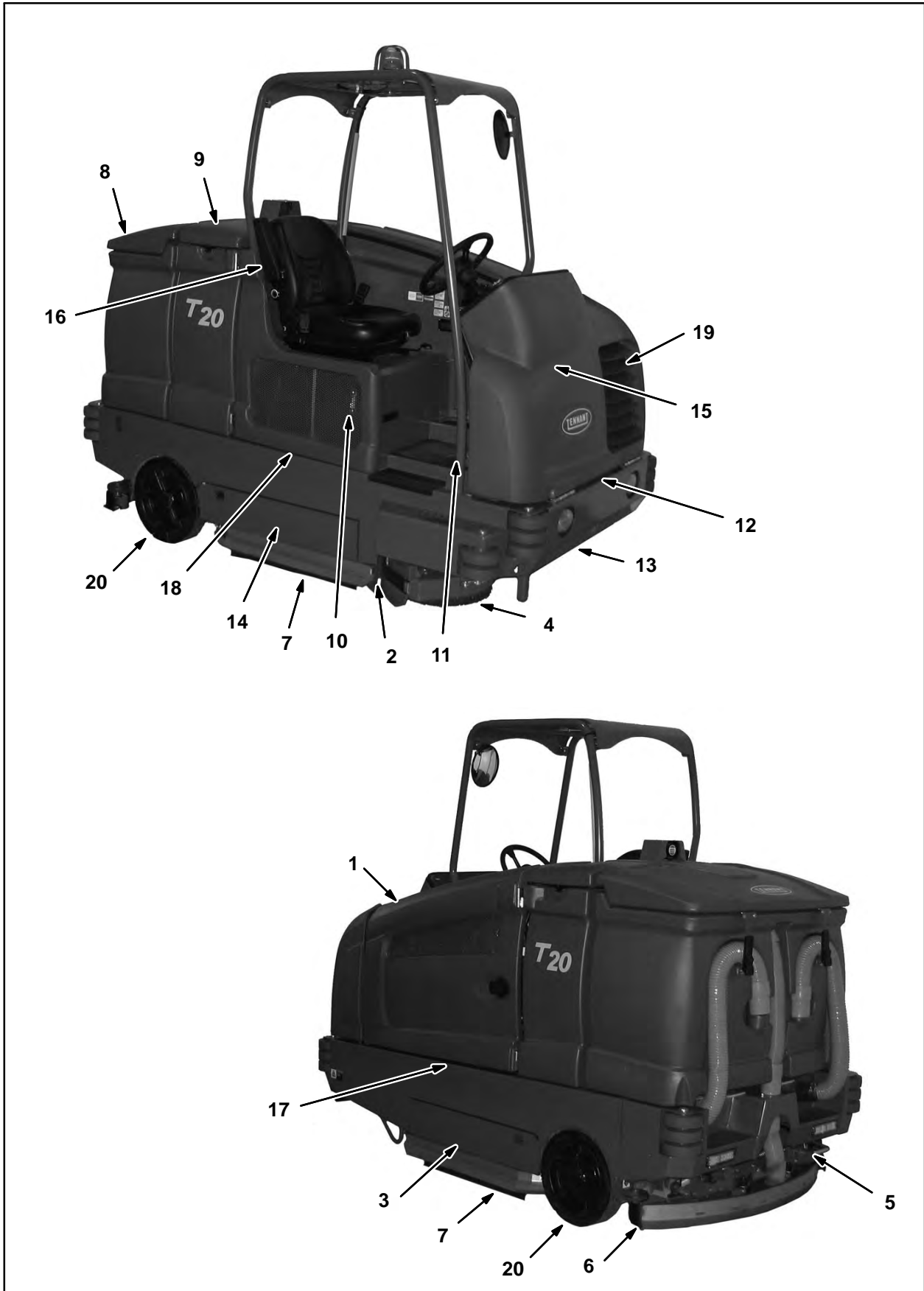

# MAINTENANCE

## MAINTENANCE CHART

The table below indicates the *Person Responsible* for each procedure.

**O = Operator.**

**T = Trained Personnel.**

Interval	Person Resp.	Key	Description	Procedure	Lubricant/ Fluid	No. of Service Points
Daily	O	1	Engine	Check oil level	EO	1
				Check coolant level in reservoir	WG	1
	O	10	Hydraulic fluid reservoir	Check fluid level	HYDO	1
	O	8, 9	Tank cover seals	Check for damage or wear	–	3
	O	3, 14	Main brushes (Cylindrical)	Check for damage and wear	–	2
	O	3, 14	Main brushes or pads (Disk)	Check for damage and wear	–	3
	O	4	Side brush (option)	Check for damage and wear	–	1
				Check squeegee blade for damage and wear	–	1
	O	6	Rear squeegee blade	Check for damage and wear	–	1
				Check deflection	–	1
	O	7	Side squeegee blades	Check for damage and wear	–	2
	O	8	Recovery tank	Clean	–	1
	O	8	Recovery tank, ES mode (option)	Clean ES filter	–	1
O	9	Solution tank, ES mode (option)	Clean	–	1	
O	5	Debris tray	Clean debris tray, screen, and hose	–	1	
50 Hours	O	16	FaST (Option)	Clean	–	1
	O	16	ec-H <sub>2</sub> O filter screen (S/N 000000–013000)	Clean	–	1
	O	3, 14	Main brushes (Cylindrical)	Rotate front to rear	–	2
	T	3, 14	Main brushes (Cylindrical)	Check brush pattern and adjust if needed	–	2
	T	13	Front wheel	Torque wheel nuts ( <b>after initial 50 hours only</b> )	–	1
	T	1	Fuel Lines	Check for damage and wear and tighten loose clamp bands	–	1
	T	15	Battery	Clean and tighten battery cable connections ( <b>after initial 50 hours only</b> )	–	1
	T	1	Engine	Check belt tension	–	1

### LUBRICANT/FLUID

EO . . . . Engine oil, 5W30 SAE–SG/SH only.

HYDO . **Tennant True** premium hydraulic fluid or equivalent

WG . . . Water and ethylene glycol anti-freeze, –34° C (–30° F)

*NOTE: More frequent maintenance intervals may be required in extremely dusty conditions.*

The table below indicates the *Person Responsible* for each procedure.

**O = Operator.**

**T = Trained Personnel.**

Interval	Person Resp.	Key	Description	Procedure	Lubricant/ Fluid	No. of Service Points
100 Hours	T	19	Radiator	Clean core exterior	–	1
	T	19	Hydraulic cooler	Clean core exterior	–	1
	T	1	Engine	Change oil and filter	EO	1
	O	13, 20	Tires	Check for damage	–	3
	T	6	Rear squeegee casters	Lubricate	SPL	2
	T	6	Rear squeegee	Check leveling	–	1
	O	2	Scrub head skirt	Check for damage or wear	–	1
	T	3, 14	Disk scrub head stop bumper	Check for damage or wear	–	2
200 Hours	T	12	Front wheel support bearings	Lubricate	SPL	2
	T	17, 18	Torque tube (Cylindrical brushes)	Lubricate	SPL	4
	T	3, 14	Torque tube (Disk brushes)	Lubricate	SPL	4
	T	3	Pivot shaft (Disk brushes)	Lubricate	SPL	4
	T	12	Steering cylinder	Lubricate	SPL	1
	T	1, 19	Radiator hoses and clamps	Check for tightness and wear	–	2
	T	11	Brake pedal	Check adjustment	–	1
400 Hours	T	1	Engine	Replace air filter	–	1
				Replace fuel filter	–	1
	T	20	Rear wheel bearings	Check, lubricate, and adjust	SPL	2
				Replace strainer outlet		1
	T	–	Hydraulic hoses	Check for wear and damage	–	All
	T	1, 19	Cooling system	Flush	WG	2
	T	13	Propelling motor	Torque shaft nut	–	1
	T	13	Front wheel	Torque wheel nuts	–	1
T	15	Battery	Clean and tighten battery cable connections	–	1	

**LUBRICANT/FLUID**

EO . . . . Engine oil, 5W30 SAE–SG/SH only.

HYDO . **Tennant True** premium hydraulic fluid or equivalent

WG . . . Water and ethylene glycol anti-freeze, –34° C (–30° F)

SPL . . . Special lubricant, Lubriplate EMB grease (Tennant part number 01433–1)

*NOTE: More frequent maintenance intervals may be required in extremely dusty conditions.*

## MAINTENANCE

The table below indicates the *Person Responsible* for each procedure.

**O = Operator.**

**T = Trained Personnel.**

Interval	Person Resp.	Key	Description	Procedure	Lubricant/ Fluid	No. of Service Points
1000 Hours	T	1, 19	Radiator hoses	Check for cracks or deterioration	–	2
	T	16	FaST system filters	Replace	–	2
1200 Hours	T	10	Hydraulic fluid filter	Replace fluid filter	–	1
2400 Hours	T	10	Hydraulic fluid reservoir	Replace strainer outlet	–	1
				Change hydraulic fluid	HYDO	1

### LUBRICANT/FLUID

EO . . . . Engine oil, 5W30 SAE–SG/SH only.

HYDO . **Tennant True** premium hydraulic fluid or equivalent

WG . . . Water and ethylene glycol anti-freeze, –34° C (–30° F)

SPL . . . Special lubricant, Lubriplate EMB grease (Tennant part number 01433–1)

*NOTE: More frequent maintenance intervals may be required in extremely dusty conditions.*

**YELLOW TOUCH POINTS**

This machine features easy to find yellow touch points for simple service items. No tools are required to perform these maintenance operations.



**LUBRICATION**

**FOR SAFETY:** Before leaving or servicing machine, stop on level surface, set parking brake, turn off machine, and remove key.

**ENGINE OIL**

Check the engine oil level daily. Change the oil and oil filter after every 100 hours of operation.

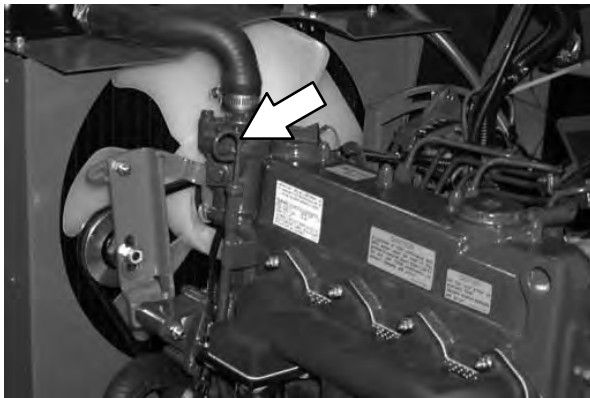

Fill the engine with oil until the oil is between the indicator marks on the dipstick. **DO NOT** fill past the top indicator mark. The engine oil capacity is 6 L (6.35 qt) with oil filter.

**SQUEEGEE CASTER BEARINGS**

Lubricate the squeegee caster bearings after every 100 hours of operation.

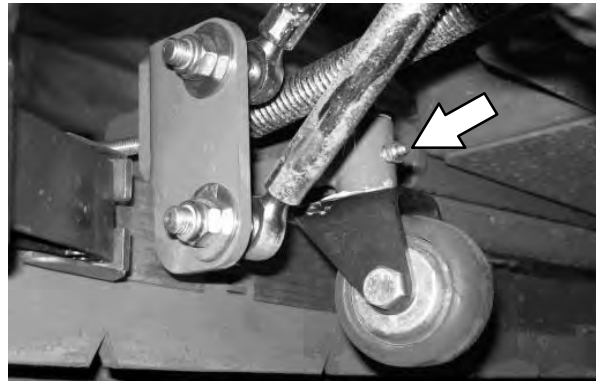

**FRONT WHEEL SUPPORT BEARING**

Lubricate the front wheel support bearings after every 200 hours of operation. Both front wheel support grease fittings are located underneath the frame support plate.



**STEERING CYLINDER BEARING**

Lubricate the steering cylinder after every 200 hours of operation. The steering cylinder bearing is located next to the front wheel support.

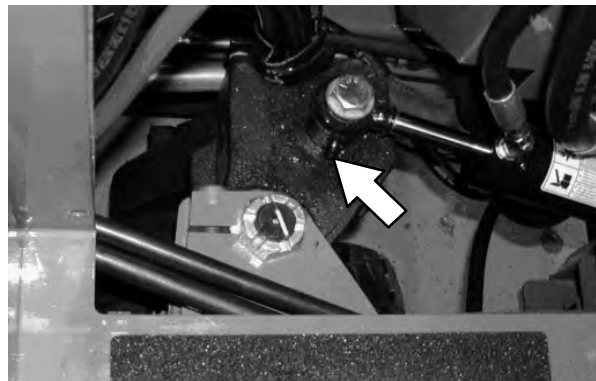

## MAINTENANCE

### REAR WHEEL BEARINGS

Inspect the rear wheel bearings for seal damage, and repack and adjust every 400 hours of operation. Use Lubriplate EMB grease (Tennant part number 01433-1).

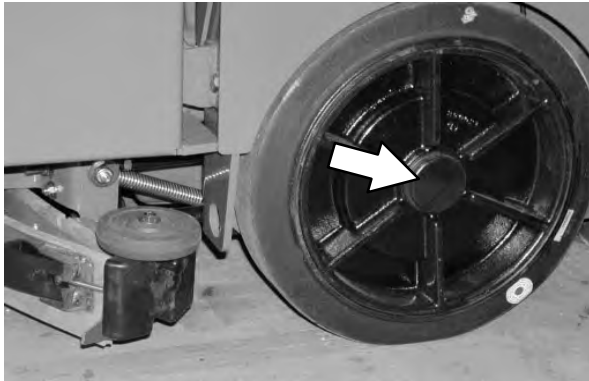

### TORQUE TUBES-DISK BRUSHES

Lubricate the three torque tube fittings after every 200 hours of operation. The first two fittings are located on each side of the machine and the third is located above the center brush.

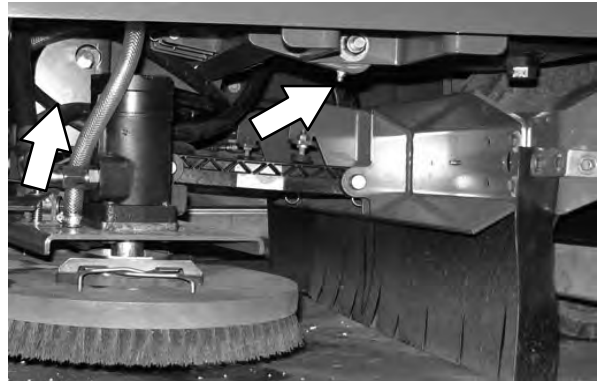

### TORQUE TUBES-CYLINDRICAL BRUSHES

Lubricate the torque tubes after every 200 hours of operation. The torque tube grease fittings on the operator side of the machine are located beneath the fuel tank.

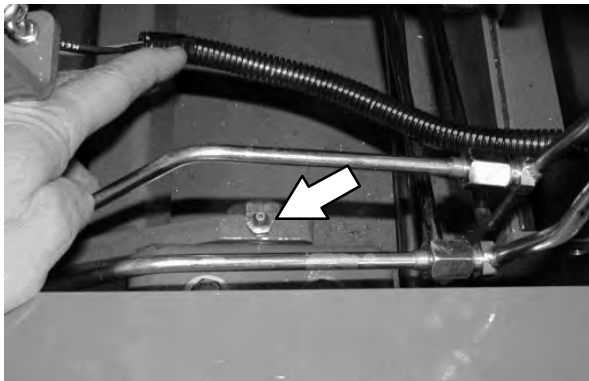

### PIVOT SHAFT-DISK BRUSHES

Lubricate the pivot shaft after every 200 hours of operation.

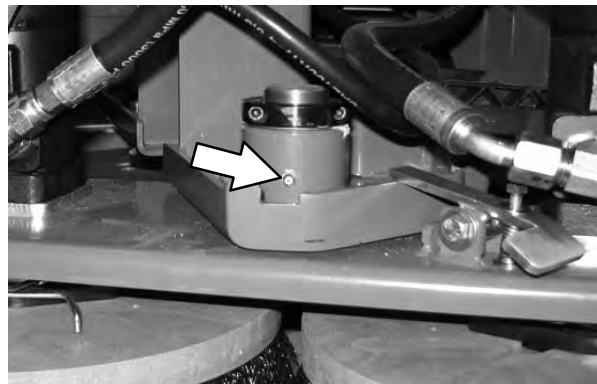

On the other side of the machine the torque tube grease fittings are located beneath the propel pump.

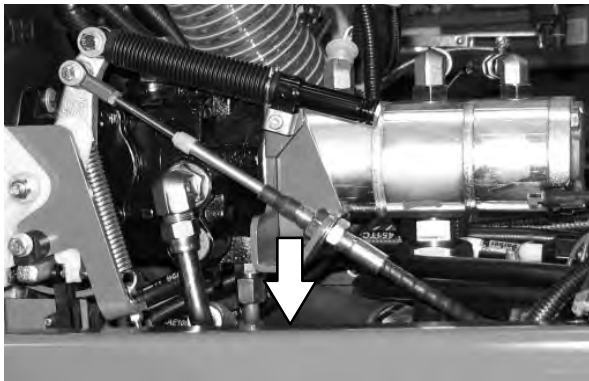

**HYDRAULICS**

**FOR SAFETY: Before leaving or servicing machine, stop on level surface, set parking brake, turn off machine, and remove key.**

Check the hydraulic fluid level at operating temperature daily. The hydraulic fluid level should be between the two lines on the hydraulic gauge.

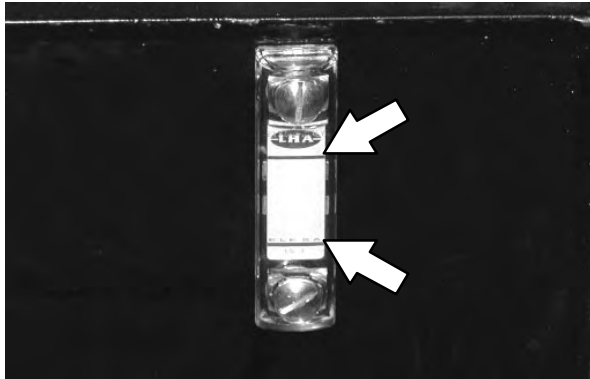

**ATTENTION! Do not overfill the hydraulic fluid reservoir or operate the machine with a low level of hydraulic fluid in the reservoir. Damage to the machine hydraulic system may result.**

Drain and refill the hydraulic fluid reservoir with new **Tennant True** premium hydraulic fluid after every 2400 hours of operation.

**⚠ WARNING: Burn hazard. Hot surface. Do NOT touch.**

Replace the filler cap after every 800 hours of operation. Apply a light film of hydraulic fluid onto the filler cap gasket before installing the cap onto the reservoir.

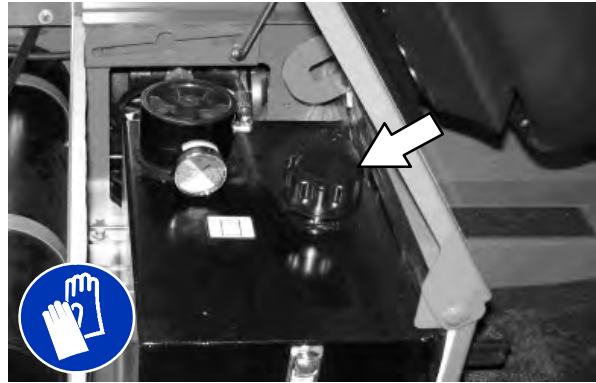

Replace the hydraulic fluid filter after every 1200 hours of operation or if the hydraulic reservoir gauge is in the yellow/red zone when the reservoir hydraulic fluid is approximately 32°C (90° F).

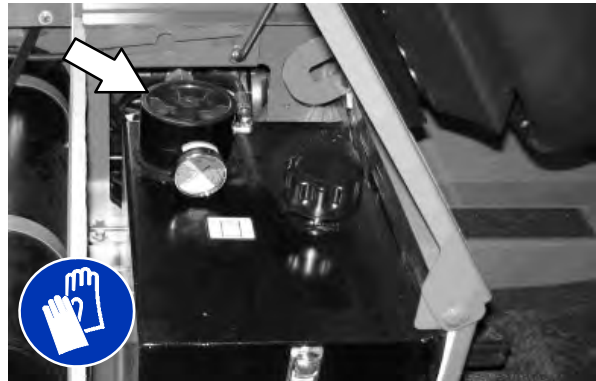

Replace the hydraulic strainer outlet after every 2400 hours of operation.

# MAINTENANCE

## HYDRAULIC FLUID

There are three fluids available for different ambient air temperature ranges:

Tennant <i>True</i> premium hydraulic fluid (Extended Life)			
Part Number	Capacity	ISO Grade Viscosity Index (VI)	Ambient Air Temperature Ranges
1057710	3.8 L (1 gal)	ISO 100 VI 126 or higher	19° C (65° F) or higher
1057711	19 L (5 gal)		
1069019	3.8 L (1 gal)	ISO 68 VI 155 or higher	7 to 43° C (45 to 110° F)
1069020	19 L (5 gal)		
1057707	3.8 L (1 gal)	ISO 32 VI 163 or higher	16° C (60° F) or lower
1057708	19 L (5 gal)		

If using a locally-available hydraulic fluid, be sure the specifications match Tennant hydraulic fluid specifications. Substitute fluids can cause premature failure of hydraulic components.

**ATTENTION! Hydraulic components depend on system hydraulic fluid for internal lubrication. Malfunctions, accelerated wear, and damage will result if dirt or other contaminants enter the hydraulic system.**

## HYDRAULIC HOSES

Check the hydraulic hoses after every 800 hours of operation for wear or damage.

**FOR SAFETY: When servicing machine, use cardboard to locate leaking hydraulic fluid under pressure.**

High pressure fluid escaping from a very small hole can almost be invisible, and can cause serious injuries.

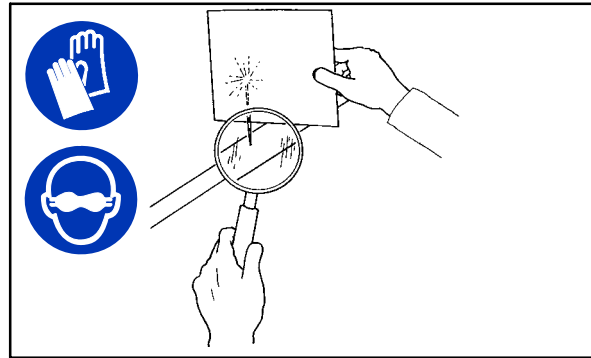

00002

Consult a physician immediately if injury results from escaping hydraulic fluid. Serious infection or reaction can occur if proper medical treatment is not given immediately.

Contact a mechanic or supervisor if a leak is discovered.

## ENGINE

**FOR SAFETY: Before leaving or servicing machine, stop on level surface, set parking brake, turn off machine, and remove key.**

### COOLING SYSTEM

**FOR SAFETY: When servicing machine, avoid contact with hot engine coolant. Do not remove cap from radiator when engine is hot. Allow engine to cool.**

Check the coolant level in the reservoir daily. The coolant level must be between the indicator marks when the engine is cold. Refer to the coolant manufacture for water/coolant mixing instructions.

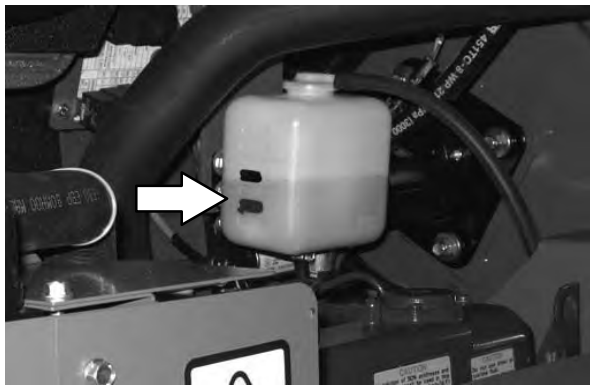

Flush the radiator and the cooling system after every 800 hours of operation.

The cooling system must be completely filled with coolant to keep the engine from overheating. When filling the cooling system, open the drain cock to bleed the air from the system.

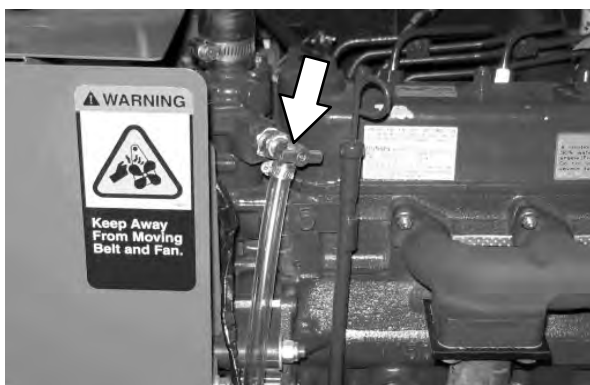

Check the radiator hoses and clamps after every 200 hours of operation. Tighten loose clamps. Replace damaged hoses and clamps.

Check the radiator hoses for cracks and deterioration after every 1000 hours of operation.



Check the radiator core exterior and hydraulic cooler fins for debris after every 100 hours of operation. Blow or rinse all dust through the grille and radiator fins, in the opposite direction of normal air flow. Be careful to not bend the cooling fins when cleaning. Clean thoroughly to prevent the fins from becoming encrusted with dust. To avoid cracking the radiator, allow the radiator and cooler fins to cool before cleaning.



## MAINTENANCE

### AIR FILTER

Replace the air filter after every 400 hours of operation.

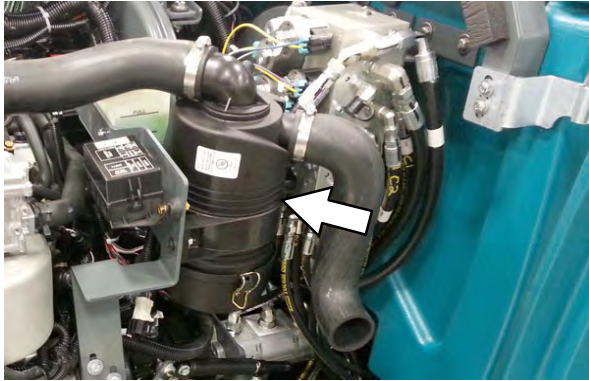

### FUEL FILTER

The fuel filter removes impurities from the fuel. Replace the fuel filter after every 400 hours of operation.

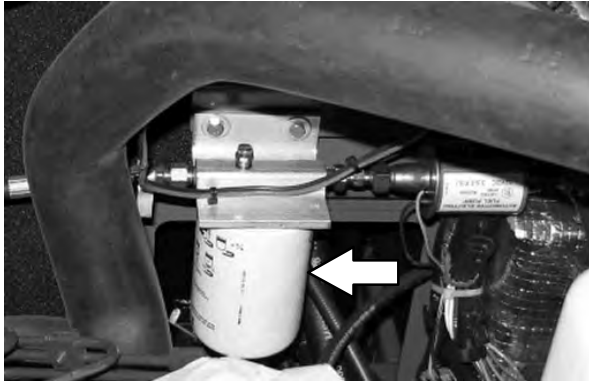

**FOR SAFETY: When servicing machine, keep flames and sparks away from fuel system service area. Keep area well ventilated.**

### FUEL LINES

Check the fuel lines every 50 hours of operation. If the clamp band is loose, apply oil to the screw of the band and securely tighten the band.



The rubber fuel lines can become worn-out whether the engine has been used much or not. Replace the fuel lines and clamp bands every two years.

**FOR SAFETY: When servicing machine, keep flames and sparks away from fuel system service area. Keep area well ventilated.**

If the fuel lines and clamp bands are found worn or damaged before two years' time; replace or repair them at once. Bleed the fuel system after replacement of any fuel lines, see PRIMING THE FUEL SYSTEM. When the fuel lines are not installed, plug both ends with clean cloth or paper to prevent dirt from entering the lines. Dirt in the lines can cause fuel injection pump malfunction.

**PRIMING THE FUEL SYSTEM**

Typical diesel fuel systems require priming to remove pockets of air from the fuel lines and fuel components. This is usually required after running out of fuel, changing fuel filter elements or repairing a fuel system component. Air in the fuel prevents smooth engine operation.

This fuel system however is self-priming. The return line comes from the top of the injector that allows the air to escape through the return line.

**ENGINE BELT**

Check the belt tension after every 50 hours of operation. Adjust tension as necessary. Proper belt tension is 13 mm (0.50 in) from a force of 4 to 5 kg (8 to 10 lb) applied at the mid-point of the longest span.

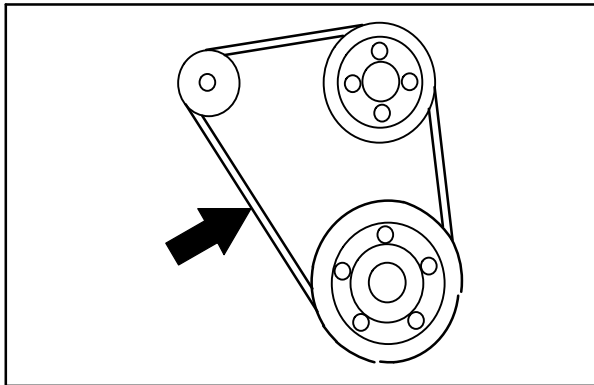

 **WARNING: Moving belt and fan. Keep away.**

**BATTERY**

Clean and tighten the battery connections after the first 50 hours of operation and after every 800 hours after that. Do not remove the vent plugs from the battery or add water to the battery.



**FOR SAFETY: When servicing machine, avoid contact with battery acid.**

## FUSES AND RELAYS

### RELAY PANEL FUSES AND RELAYS

*Fuses* are one-time protection devices designed to protect the wire harness by stopping the flow of current in the event of a circuit overload. *Relays* switch the electrical power going to the machine electrical systems on/off. Remove the relay panel cover to access *fuses* and *relays*.

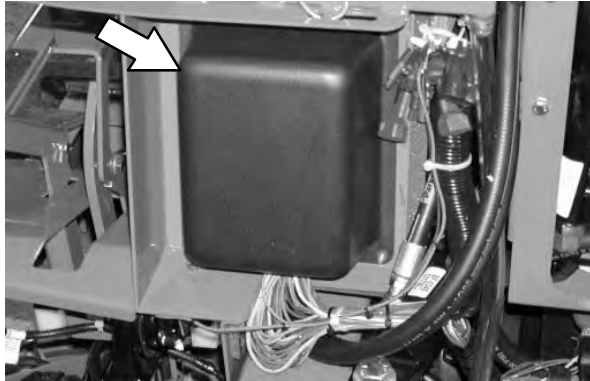

**NOTE:** Always replace a fuse with a fuse of the same amperage. Extra 15 Amp fuses are provided inside the relay panel drawer on the relay panel.

Refer to the diagram below for locations of the *fuses* and *relays* on the relay panel. The M10 relay for the optional spray nozzle is located behind the battery.

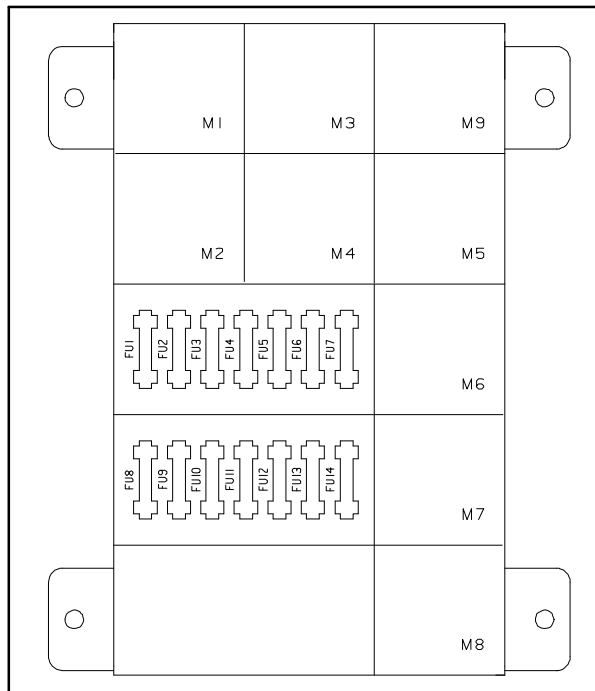

Refer to the table below for the *fuses* and circuits protected.

Fuse	Rating	Circuit Protected
FU1	15 A	Auxiliary Relays/Engine Controls
FU2	15 A	Not Used
FU3	15 A	Horn
FU4	15 A	Cab wiper/defrost (Option)
FU5	15 A	Scrub Vacuum/Main Brush/Squeegee Down
FU6	15 A	Enable/Side Brush
FU7	15 A	Solution/Auto Fill/Reverse
FU8	15 A	ES/FaST/Detergent/Spray Wand
FU9	15 A	Lights
FU10	15 A	Cab fans (Option)
FU11	15 A	Not Used: Options
FU12	15 A	Spray Nozzle Pump
FU13	15 A	Not Used (S/N 000000-013000)
FU13	15 A	Solution Pump (S/N 013001- )
FU14	15 A	Not Used

-	20 A	ec-H2O (near ignition switch)
---	------	-------------------------------

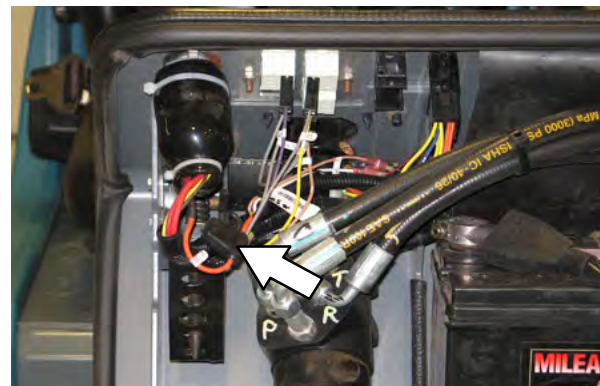

Refer to the table below for the *relays* and circuits controlled.

Relay	Rating	Circuit Controlled
M1	12 VDC, 40 A	Auxiliary 1
M2	12 VDC, 40 A	Auxiliary 2
M3	12 VDC, 40 A	Not Used
M4	12 VDC, 40 A	Reverse
M5	12 VDC, 40 A	Horn
M6	12 VDC, 40 A	Shutdown
M7	12 VDC, 40 A	Starter
M8	12 VDC, 40 A	Not Used
M9	12 VDC, 40 A	Not Used
M10	12 VDC, 40 A	Not Used
M11	12 VDC, 40 A	FaST Water Pump (located in FaST harness)
M12	12 VDC, 40 A	Spray Wand (located in Spray wand harness)

**ENGINE HARNESS FUSES AND RELAYS**

The *engine harness fuses and relays* are located in the fuse box inside the engine compartment. Refer to the fuse box cover for locations of engine harness fuses and relays.

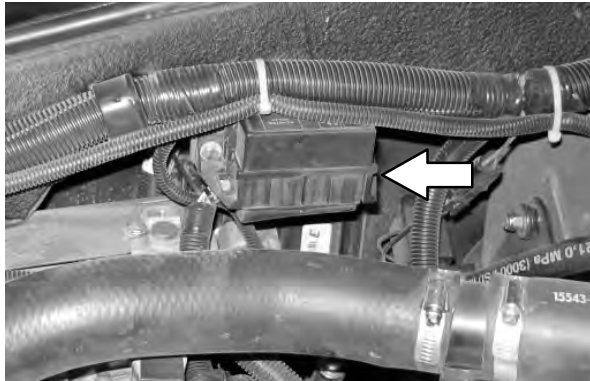

*NOTE: Always replace a fuse with a fuse of the same amperage.*

**OPTIONAL RELAYS**

The optional spray nozzle or pressure wand relay is located behind the battery. The optional FaST scrubbing system relay is located behind the seat.

Relay	Rating	Circuit Controlled
-	12 VDC. 40 A	Spray Wand
-	12 VDC. 40 A	Pressure Washer
-	12 VDC. 40 A	FaST

**CIRCUIT BREAKERS (ec-H2O)**

Circuit breakers are resettable electrical circuit protection devices that stop the flow of current in the event of a circuit overload. Once a circuit breaker is tripped, allow breaker to cool and then press the reset button to manually reset the breaker.



**SCRUB BRUSHES AND PADS**

The machine can be equipped with either *disk* or *cylindrical* scrub brushes, or cleaning pads. Check scrub brushes or pads daily for wire or string tangled around the brush or brush drive hub. Also check brushes or pads for damage and wear.

**DISK BRUSHES**

Replace the brush when it no longer cleans effectively or when the bristles are worn down to the yellow indicators.

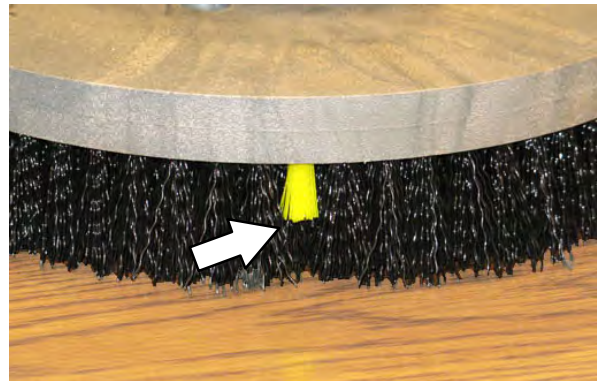

Cleaning pads must be placed on pad drivers before they are ready to use. The cleaning pad is held in place the center disk.

Cleaning pads need to be cleaned immediately after use with soap and water. Do not wash the pads with a pressure washer. Hang pads, or lay pads flat to dry.

*NOTE: Always replace brushes and pads in sets. Otherwise one brush or pad will be more aggressive than the other.*

## MAINTENANCE

### REPLACING DISK BRUSHES OR PAD DRIVER

1. Raise the scrub head.

**FOR SAFETY: Before leaving or servicing machine, stop on level surface, set parking brake, turn off machine, and remove key.**

2. Open the right outer brush door.

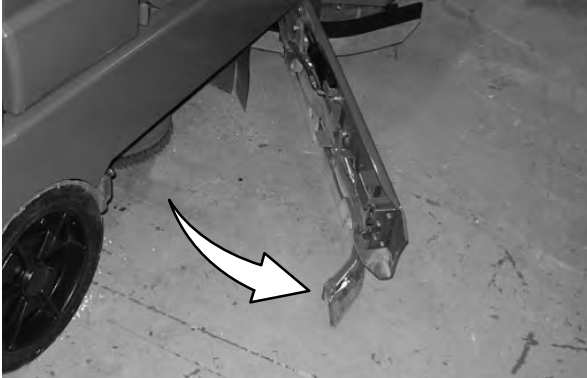

3. Hold down the release lever and rotate the adjustable disk brush head until it is possible to access the center brush.

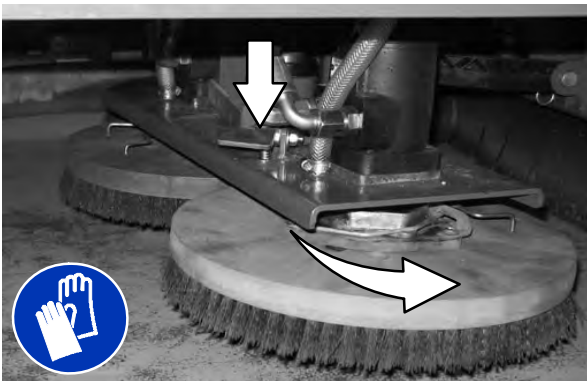

4. Turn the brushes until the spring handles are visible.
5. Squeeze the spring handles and let the brushes drop to the floor.



6. Remove the brushes from underneath the scrub head.
7. Set the brush spring open on the new brush to make installation easier.



8. Place the new brushes underneath the scrub head and lift each brush up onto the hub until the brush locks onto the hub.
9. Rotate the disk brush head back to the scrub position until the head locks into place.

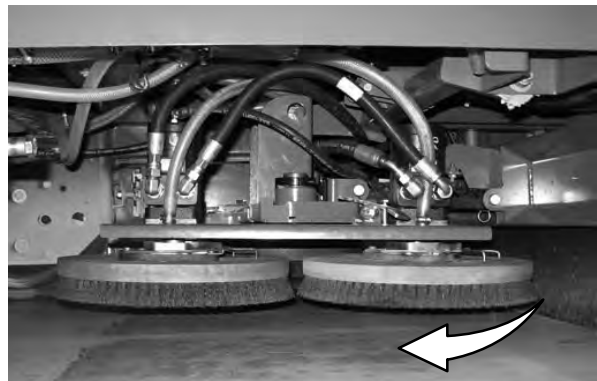

10. Close the right outer brush door.
11. Open the left outer brush door and repeat the procedure for the left brush.

*NOTE: The center brush can only be accessed from the right side of the machine.*

## REPLACING DISK PADS

**FOR SAFETY: Before leaving or servicing machine, stop on level surface, set parking brake, turn off machine, and remove key.**

1. Remove the pad driver from the machine.
2. Squeeze the spring clip together to remove the center disk.



3. Flip or replace the scrub pad, center the scrub pad on the pad driver. Then reinstall the center disk to secure the pad in place on the pad driver.



4. Reinsert the pad driver into the machine.

## CHECKING THE DISK SCRUB HEAD STOP BUMPERS

The disk scrub head stop bumpers keep the scrub head parallel with the floor when in the raised position. This protects the brushes when transporting. Check the lift stop bumpers after every 100 hours of operation for wear or damage.

1. Raise the scrub head.

**FOR SAFETY: Before leaving or servicing machine, stop on level surface, set parking brake, turn off machine, and remove key.**

2. Open the right and left outer brush doors.



3. Inspect the scrub head stop bumpers. Adjust the bumpers if the scrub head is not parallel with the floor. Replace worn or damaged bumpers.

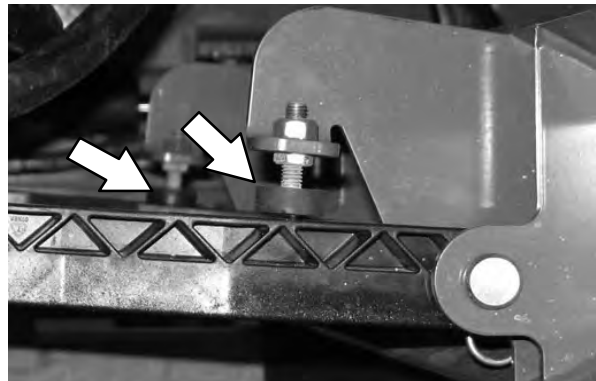

## MAINTENANCE

### CYLINDRICAL BRUSHES

**FOR SAFETY: Before leaving or servicing machine, stop on level surface, set parking brake, turn off machine, and remove key.**

Check the main brushes daily for tangled wire or string, wear, and damage.

Replace the brushes when they no longer clean effectively.

Rotate the brushes from front to rear after every 50 hours of machine operation for maximum brush life and best scrubbing performance.

*NOTE: Replace brushes in sets of two. Otherwise one scrub brush may scrub more aggressively than the other.*

### REPLACING OR ROTATING CYLINDRICAL BRUSHES

The front brush can be accessed on the left side of the machine and rear brush can be accessed on the right side of the machine.

1. Raise the scrub head.

**FOR SAFETY: Before leaving or servicing machine, stop on level surface, set parking brake, turn off machine, and remove key.**

2. Open the outer brush doors.

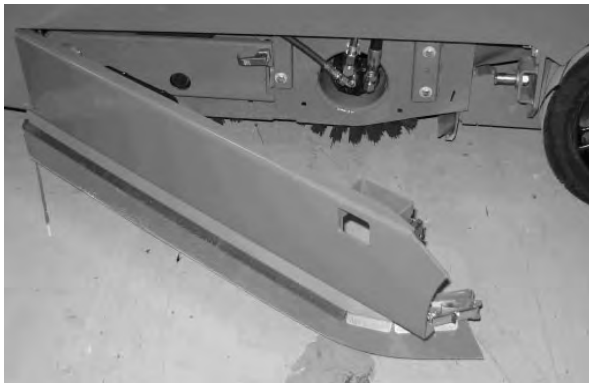

3. Open the inner brush doors.

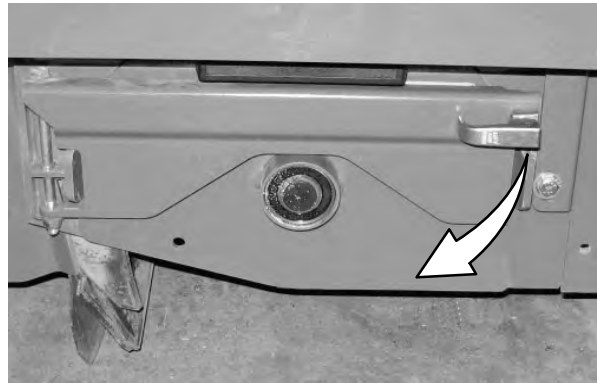

4. Remove the brush idler plates.

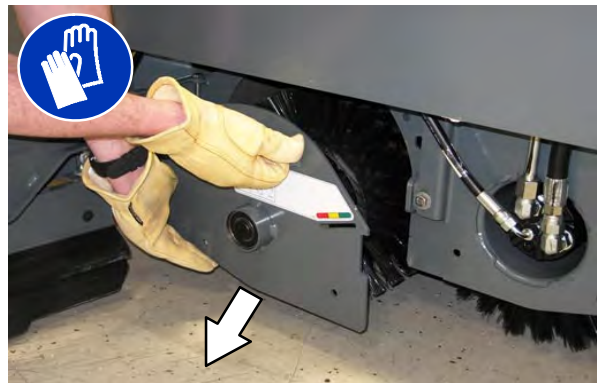

5. Pull the brushes out from the scrub head.



6. Install the new or rotated brushes by pushing down on the ends while sliding them onto the drive motor hubs.



7. If rotating the brushes, always rotate the front with the back so that they wear evenly. They may be rotated end-for-end as well.

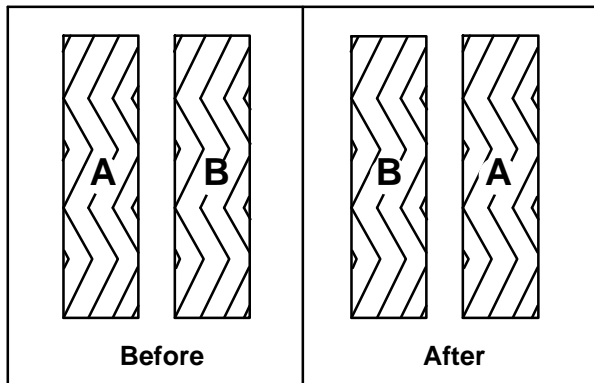

8. Reinstall the brush idler plates.
9. Close the inner and outer brush doors.
10. Check the brush pattern and adjust if needed after rotating them. Refer to *CHECKING AND ADJUSTING THE MAIN BRUSH PATTERN*.
11. Check the brush pattern and adjust if needed after rotating them. Refer to *CHECKING CYLINDRICAL BRUSH PATTERN*.

**CHECKING CYLINDRICAL BRUSH PATTERN**

1. Apply chalk, or a similar marking material, to a smooth and level section of the floor.

*NOTE: If chalk or other material is not available, allow the brush to spin on the floor for two minutes. A polish mark will remain on the floor.*

2. Raise the scrub head, then position the brushes over the chalked area.
3. Set the parking brake.
4. Press the *1-STEP Scrub button* to lower the scrub head. Set the brush pressure to the lowest setting and allow the brushes to operate for 15 to 20 seconds. Keep the scrub head in one spot in the chalked area.
5. Raise the scrub head, release the parking brake, and drive the machine away from the chalked area.

**FOR SAFETY: Before leaving or servicing machine, stop on level surface, set parking brake, turn off machine, and remove key.**

6. Observe the brush patterns. If the brush pattern is the same width across the entire length of each brush and both brushes are the same width, no adjustment is necessary.

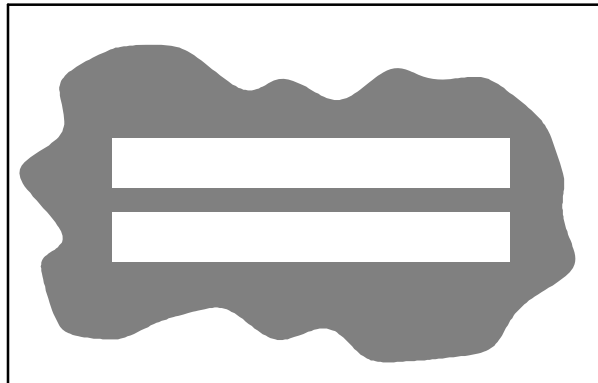

## MAINTENANCE

7. If the brush patterns are tapered, see *ADJUSTING THE CYLINDRICAL BRUSH TAPER* section of this manual.

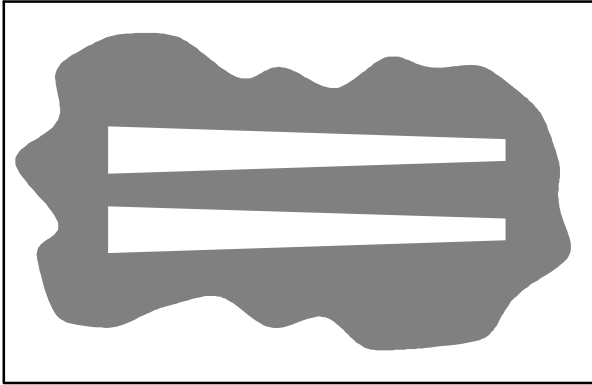

8. The brush patterns should be 50 to 75 mm (2 to 3 in) wide with the brushes in the lowered position and both patterns should be the same width. If the width of the brushes is not the same, see *ADJUSTING THE CYLINDRICAL BRUSH WIDTH* section of this manual.

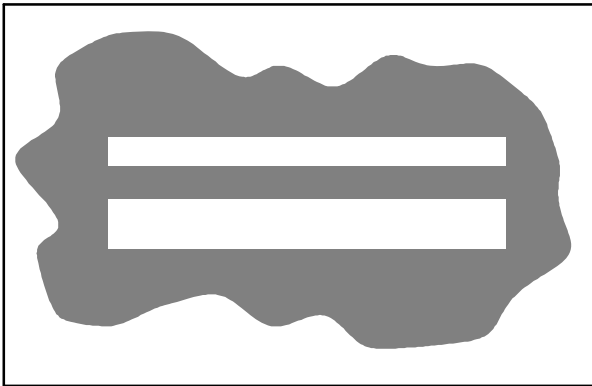

### ADJUSTING THE CYLINDRICAL BRUSH TAPER

1. Loosen the four mounting bolts on the brush drive housing.

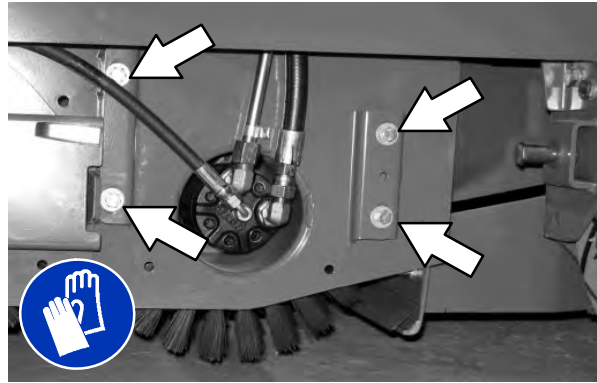

2. Move the brush drive housing up to decrease the pattern width on that side of the scrub head or down to increase the pattern width on that side of the scrub head.
3. Tighten the mounting bolts.
4. Recheck the pattern. Readjust if necessary.

### ADJUSTING THE CYLINDRICAL BRUSH WIDTH

1. Adjust the length of the drag links on both sides of the scrub head. Lengthen the drag links to increase the rear brush pattern width. Shorten the drag links to increase the front brush pattern. Always adjust the nut on each drag link an equal number of turns.

**NOTE:** Two full turns of the drag link adjustment bolt will change the brush pattern approximately 25 mm (1 in).

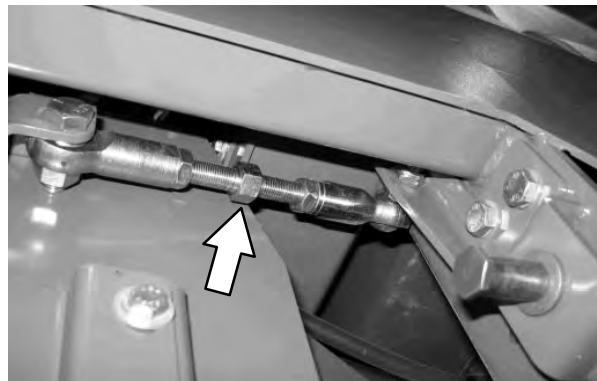

2. Recheck the pattern. Readjust if necessary.

**SIDE BRUSH (OPTION)**

**FOR SAFETY:** Before leaving or servicing machine, stop on level surface, set parking brake, turn off machine, and remove key.

Check the side brush daily for wear or damage. Remove any tangled string or wire from the side brush or side brush drive hub.

**REPLACING THE SIDE BRUSH**

Replace the brush when it no longer cleans effectively or when the bristles are worn down to the yellow indicators.

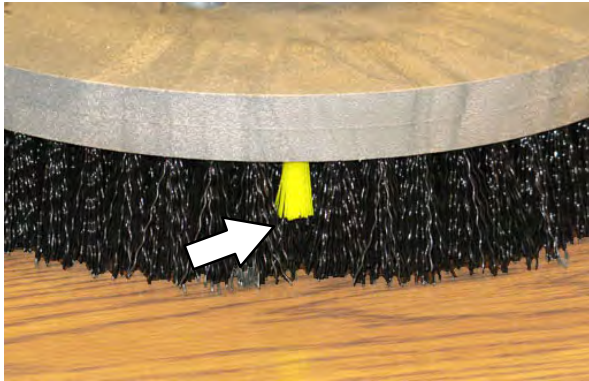

1. If necessary, raise the side brush.
2. Turn the brush until the spring handles are visible through the access hole in the side brush assembly.
3. Squeeze the spring handles and let the side brush drop to the floor.

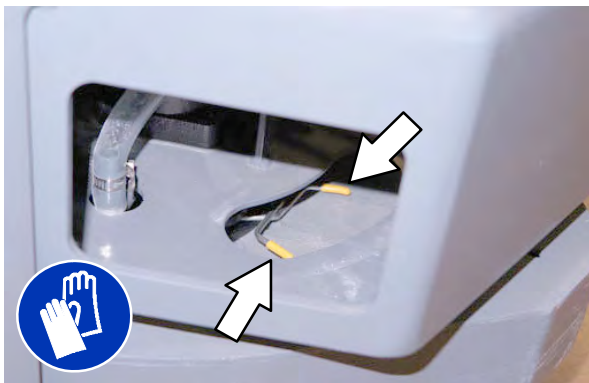

4. Remove the side brush from underneath the side brush assembly.



5. Set the brush spring open on the new brush to make installation easier.



6. Place the new side brush underneath the side brush assembly and lift the side brush up onto the side brush hub until the brush locks onto the hub.

## FaST SYSTEM

### REPLACING THE FaST-PAK CARTON

**FOR SAFETY: Before leaving or servicing machine, stop on level surface, set parking brake, turn off machine, and remove key.**

1. Open the side access door.
2. Slide the seat completely forward.
3. Squeeze the button on the FaST supply hose connector, then pull the empty FaST-PAK carton out from the compartment and discard.



4. Remove the perforated knock outs from the new FaST-PAK carton. Do Not remove the bag from the carton. Pull out the hose connector located on the bottom of the bag and remove the hose cap from the connector.

*NOTE: The FaST-PAK Floor Cleaning Concentrate is specially designed for use with the FaST system scrubbing application. NEVER use a substitute. Other cleaning solutions may cause FaST system failure.*

5. Slide the FaST-PAK carton into the FaST-PAK bracket.
6. Connect the FaST supply hose to the FaST-PAK hose connector.
7. Scrub with the FaST system for a few minutes to allow the detergent to reach maximum foaming.

**CLEANING THE FaST SUPPLY HOSE CONNECTOR**

Soak the connector in warm water if detergent buildup is visible. When a FaST-PAK carton is not installed, store the supply hose connector on the storing plug to prevent the hose from clogging.

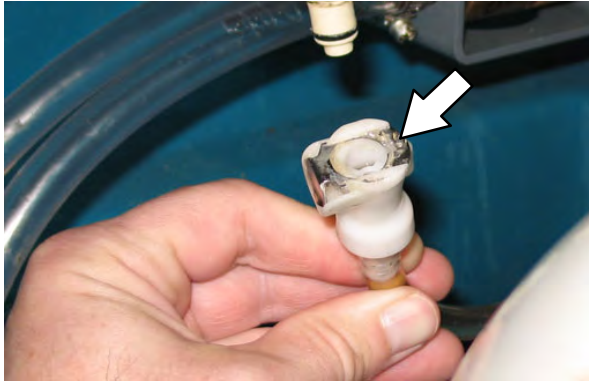
**CLEANING THE FaST SYSTEM FILTER SCREEN**

The FaST system filter screen filters water from the solution tank as the water flows into the FaST system.

Remove the filter screen bowl and clean the filter screen after every 50 hours of operation. Empty the solution tank before removing the filter.

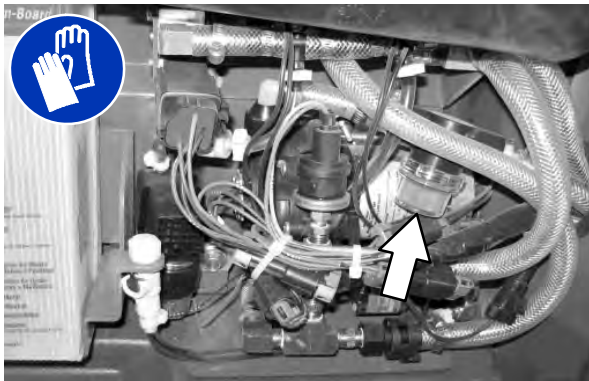
**REPLACING THE FaST SYSTEM FILTERS**

Replace the FaST system filters after every 1000 hours of operation. Empty the solution tank before replacing the filters.

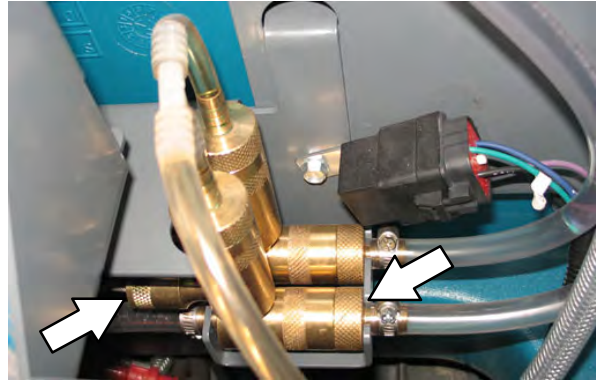

## ec-H2O MODULE FLUSH PROCEDURE

This procedure is only required when an alarm sounds and the ec-H2O system indicator light begins to blink red.

### Ec-H2O Module FLUSH PROCEDURES (S/N 000000-013000)

**FOR SAFETY: Before leaving or servicing machine, stop on level surface, set parking brake, turn off machine.**

1. Remove both flush hoses from the storage bag located behind the operator seat.
2. Lock the operator seat cover open.
3. Disconnect the ec-H2O system intake hose from the solution supply hose and connect the intake flush hose (gray connector) to the ec-H2O system intake hose.



4. Disconnect the ec-H2O system outlet hose from the hose to the scrub head and connect the outlet flush hose (black connector) to the ec-H2O system outlet hose.



5. Place the ec-H2O system intake hose into a container containing 5 gallons (19 liters) of white or rice vinegar. Place the outlet hose into an empty bucket.



6. Turn the key to the on position without starting the engine.
7. Press and release the ec-H2O module flush switch to start the flush cycle.

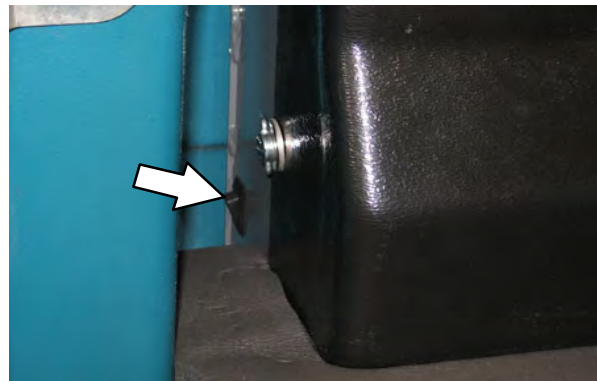

**NOTE:** The module will automatically shut off when the flush cycle is complete (approx. 7 minutes). The module must run the full 7 minute cycle in order to reset the system indicator light and alarm.

8. After the 7 minute flush cycle, remove the siphon hose from the container of vinegar and place the siphon hose into a container of cool clean water. Press the flush switch again to rinse out any remaining vinegar from the module. After 1–2 minutes, press the flush switch to turn off the module.
9. Disconnect the flush hoses from the *ec-H2O* system intake hose and outlet hose and return the flush hoses to the storage bag.
10. Reconnect *ec-H2O* intake and outlet hoses. If the *ec-H2O* system indicator light continues to flash, repeat the flush procedure. If the problem persists, contact an Authorized Service Center.
11. Insert the outlet and intake hoses between the *ec-H2O* assembly and the bracket.



*NOTE: The outlet and intake hoses must be down between the *ec-H2O* assembly and the bracket so they are not pinched or damaged when the operator seat cover is closed.*

12. Close the operator seat cover.

## MAINTENANCE

### Ec-H2O Module FLUSH PROCEDURES (S/N 013001- )

**FOR SAFETY: Before leaving or servicing machine, stop on level surface, set parking brake, turn off machine.**

1. Empty the solution tank.
2. Remove the outlet flush hose (black connector) from the storage bag located behind the operator seat.
3. Lock the operator seat cover open.
4. Disconnect the *ec-H2O* system outlet hose from the hose to the scrub head and connect the outlet flush hose (black connector) to the *ec-H2O* system outlet hose.



5. Place the outlet hose into an empty bucket.



6. Pour 5 gallons (19 liters) of white or rice vinegar into the empty solution tank.
7. Turn the key to the on position without starting the engine.

8. Press and release the *ec-H2O* module flush switch to start the flush cycle.

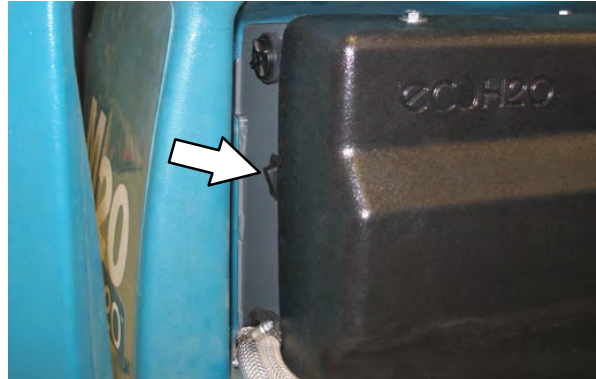

*NOTE: The module will automatically shut off when the flush cycle is complete (approx. 7 minutes). The module must run the full 7 minute cycle in order to reset the system indicator light and alarm.*

9. After the 7 minute flush cycle, drain and rinse any vinegar from the solution tank. Add 3 gallons (11 liters) of cool clean water to the solution tank. Press the flush switch again to rinse out any remaining vinegar from the module. After 1–2 minutes, press the flush switch to turn off the module.
10. Disconnect the flush hose from the *ec-H2O* system outlet hose and return the flush hose to the storage bag.
11. Reconnect *ec-H2O* outlet hose. If the *ec-H2O* system indicator light continues to flash, repeat the flush procedure. If the problem persists, contact an Authorized Service Center.

12. Insert the outlet hose between the *ec-H2O* assembly and the bracket.



*NOTE: The outlet and intake hoses must be down between the *ec-H2O* assembly and the bracket so they are not pinched or damaged when the operator seat cover is closed.*

13. Close the operator seat cover.

### CLEANING THE *ec-H2O* FILTER SCREEN (S/N 000000-013000)

Remove and clean the *ec-H2O* filter screen after every 50 hours of operation.

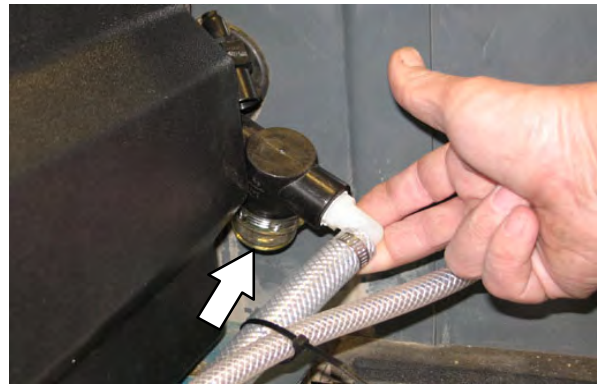

## SQUEEGEE BLADES

Check the squeegee blades for damage and wear daily. When the blades become worn, rotate the blades end-for-end or top-to-bottom to a new wiping edge. Replace blades when all edges are worn.

Check the deflection of the squeegee blades daily or when scrubbing a different type of surface. Check the leveling of the rear squeegee every 100 hours of operation.

### REPLACING (OR ROTATING) THE REAR SQUEEGEE BLADES

1. Lower the scrub head.

**FOR SAFETY: Before leaving or servicing machine, stop on level surface, set parking brake, and turn off machine.**

2. Disconnect the vacuum hose from the rear squeegee assembly.

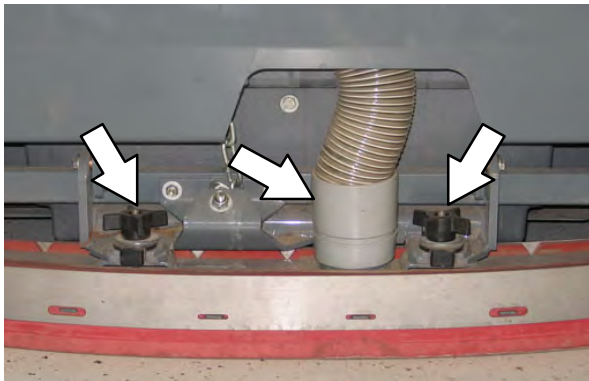

3. Remove both mounting knobs from the rear squeegee assembly.
4. Turn on the machine, raise the scrub head, and turn off the machine.
5. Remove the rear squeegee assembly from the machine.

6. Loosen the rear retaining band tension latch and open the retaining band.

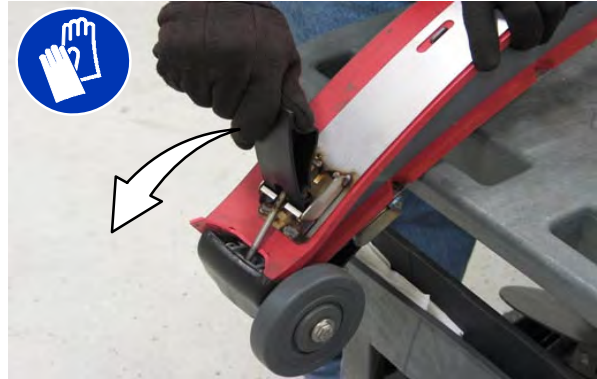

7. Remove the rear squeegee.



8. Install the new rear squeegee blade or rotate the existing blade to the new edge. Be sure all the holes in the squeegee blade are hooked onto the tabs.



9. Reinstall the rear retaining band aligning the tabs with the holes.



10. Tighten the rear retaining band tension latch.

11. Loosen the front retaining band tension latch and open the retaining band.



12. Remove the front squeegee.



13. Install the new front squeegee blade or rotate the existing blade to the new edge. Be sure the holes in the squeegee blade are hooked onto the tabs.



## MAINTENANCE

14. Reinstall the front retaining band aligning the tabs with the notches.



15. Tighten the front retaining band tension latch.
16. Reinstall the rear squeegee assembly onto the machine.
17. Check and adjust the rear squeegee if necessary. Refer to *ADJUSTING THE REAR SQUEEGEE BLADE DEFLECTION* and *LEVELING THE REAR SQUEEGEE* sections of this manual.

## REPLACING OR ROTATING THE SIDE SQUEEGEE BLADES

1. If necessary, raise the scrub head.

**FOR SAFETY: Before leaving or servicing machine, stop on level surface, set parking brake, turn off machine, and remove key.**

2. Open the outer brush doors.
3. Unhook the latch on the side squeegee retaining band from the side squeegee assembly.

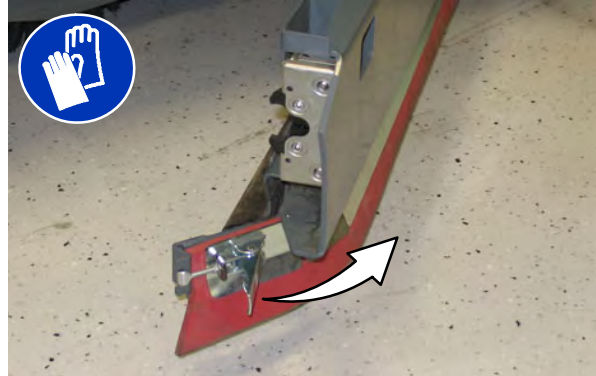

4. Remove the retaining band from the side squeegee assembly.

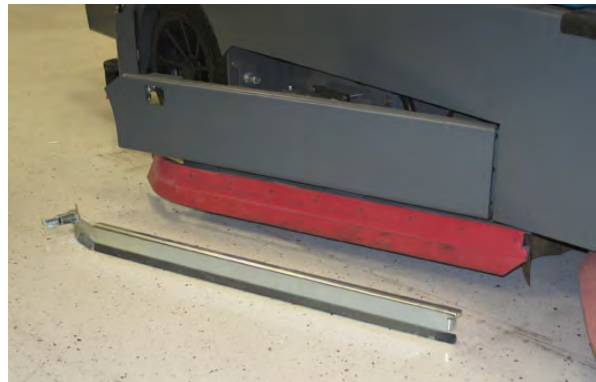

5. Remove the side squeegee blade. If the outer edge of the squeegee blade is not worn, rotate the squeegee blade with the blade from the other side of the machine. Discard the squeegee blade if both edges are worn.

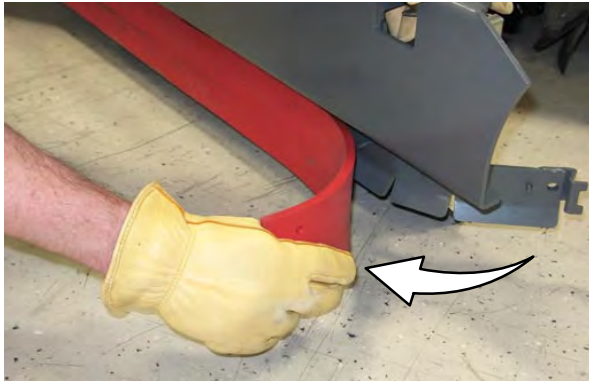

6. Install the new or rotated squeegee blades.



7. Reattach the side squeegee retaining band to the side squeegee assembly.



8. Hook the latch on the side squeegee retaining band.

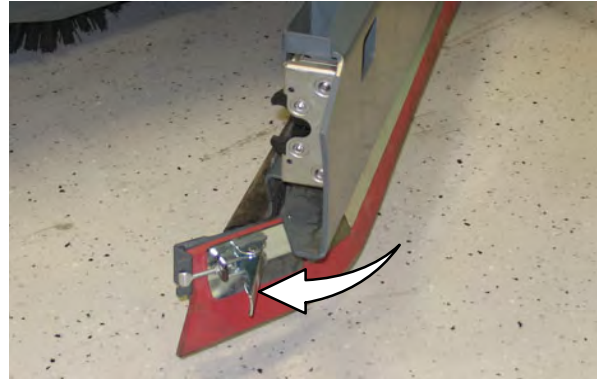

9. Close the outer brush door.

## MAINTENANCE

### REPLACING OR ADJUSTING THE SIDE BRUSH SQUEEGEE BLADE (OPTION)

**FOR SAFETY:** Before leaving or servicing machine, stop on level surface, set parking brake, turn off machine, and remove key.

Check the side brush squeegee blade for damage and wear daily. Replace the blade if the leading edge is torn or worn half-way through the thickness of the blade.

1. Lower the scrub head.
2. Pull the pins and remove the squeegee bumper.

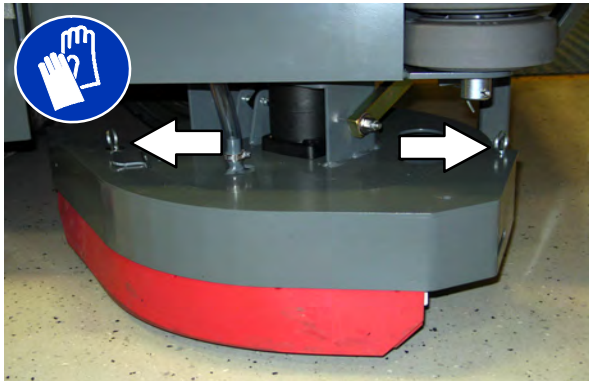

3. Open the retaining band tension latch.

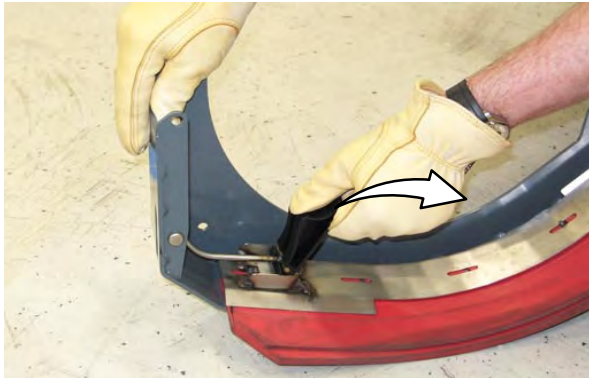

4. Remove the squeegees, spacer, and retainer from the squeegee bumper.

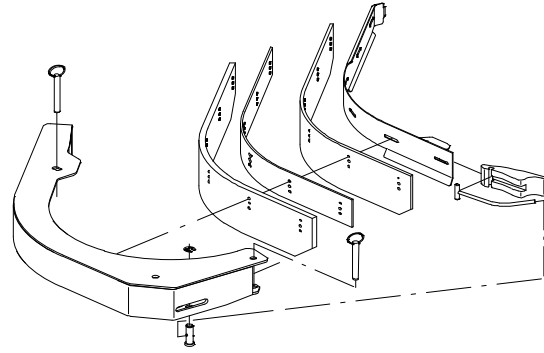

*NOTE: The side brush squeegee blades have different holes for changing height adjustment.*

5. Reinstall the squeegees, spacer, and retainer to the squeegee bumper by aligning the appropriate holes to the pins on the bumper.

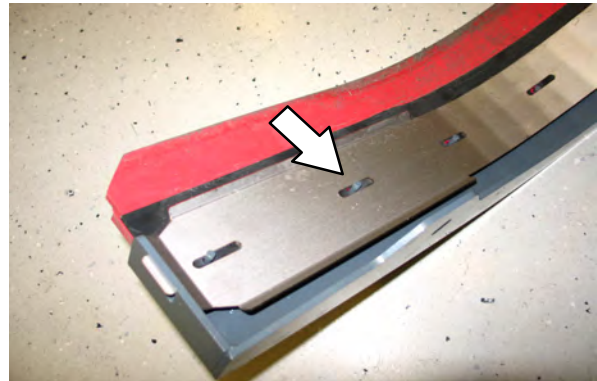

6. Reinstall the retaining band tension latch.
7. Reinstall the squeegee bumper and reinsert the pins.

**LEVELING THE REAR SQUEEGEE**

Leveling the squeegee assures the entire length of the squeegee blade is in even contact with the surface being scrubbed. Perform this adjustment on an even and level floor.

1. Lower the squeegee and drive the machine forward a few meters (feet).

**FOR SAFETY: Before leaving or servicing machine, stop on level surface, set parking brake, turn off machine, and remove key.**

2. Look at the deflection of the squeegee over the full length of the squeegee blade.
3. If the deflection is not the same over the full length of the blade, turn the squeegee levelling nut to make adjustments.

***DO NOT** disconnect the suction hose from the squeegee frame when leveling squeegee.*

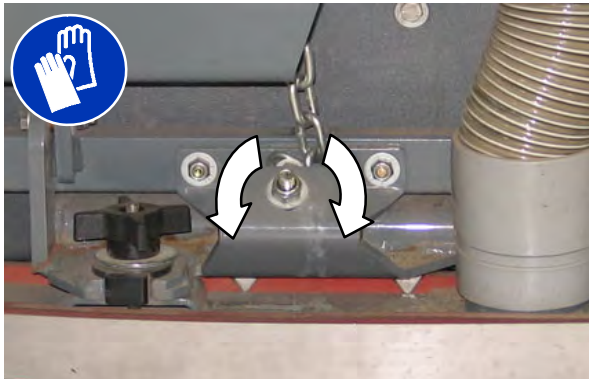

4. Turn the squeegee leveling nut counter-clockwise to decrease the deflection at the ends of the squeegee blade.

Turn the squeegee leveling nut clockwise to increase the deflection at the ends of the squeegee blade.

5. Drive the machine forward with the squeegee down to recheck the squeegee blade deflection if adjustments were made.
6. Readjust the squeegee blade deflection if necessary.

## MAINTENANCE

### ADJUSTING THE REAR SQUEEGEE BLADE DEFLECTION

Deflection is the amount of curl the overall squeegee blade has when the machine moves forward. The best deflection is when the squeegee wipes the floor dry with a minimal amount of deflection.

*NOTE: Make sure the squeegee is level before adjusting the deflection. See LEVELING THE REAR SQUEEGEE.*

1. Lower the squeegee and drive the machine forward a few meters (feet).

**FOR SAFETY: Before leaving or servicing machine, stop on level surface, set parking brake, turn off machine, and remove key.**

2. Look at the amount of deflection or “curl” of the squeegee blade. The correct amount of deflection is 12 mm (0.50 in) for scrubbing smooth floors and 15 mm (0.62 in) for rough floors.

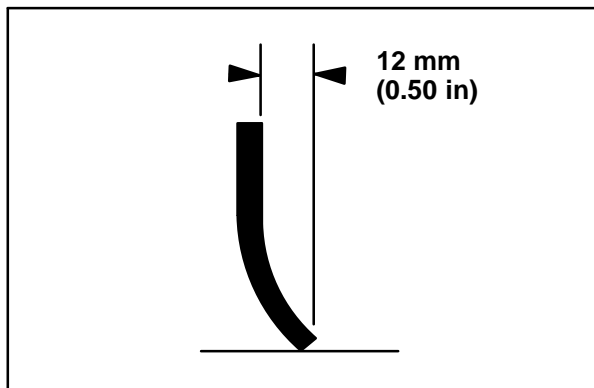

3. To adjust the overall squeegee blade deflection, turn the adjustment knobs counterclockwise to increase deflection or clockwise to decrease deflection.

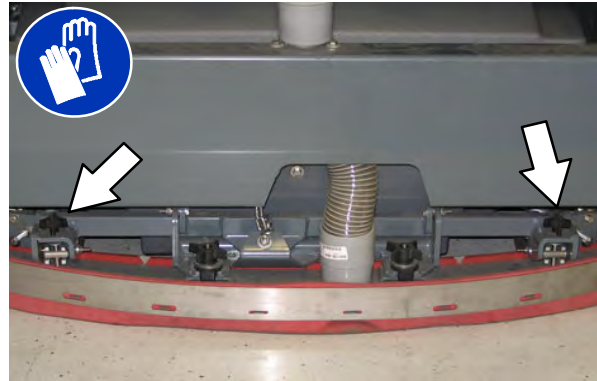

4. Drive the machine forward again to recheck the squeegee blade deflection after adjustments are made.
5. Readjust the squeegee blade deflection if necessary.

---

**SKIRTS AND SEALS**

---

**FOR SAFETY:** Before leaving or servicing machine, stop on level surface, set parking brake, turn off machine, and remove key.

**SCRUB HEAD SKIRT**

Check the skirt for damage and wear after every 100 hours of operation.

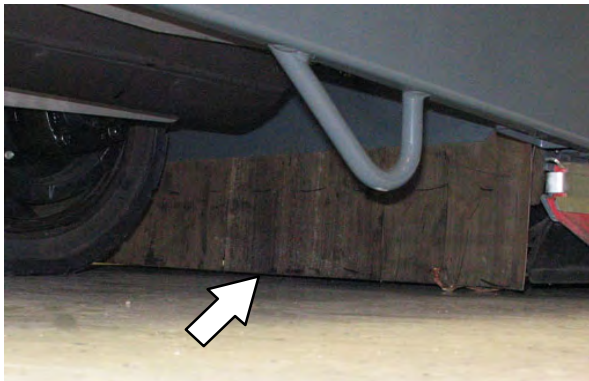

The skirts should be between 0 to 6 mm (0 to 0.25 in) from the floor when the scrub head is down.

**RECOVERY TANK SEAL**

Check the recovery tank cover seal for damage and wear daily.

**SOLUTION TANK SEALS**

Check each solution tank cover seal for damage and wear daily.



# MAINTENANCE

## BRAKES AND TIRES

### BRAKES

The mechanical brakes are located on the rear wheels. The brakes are operated by the foot brake pedal and connecting cables.

Check the brake adjustment after every 200 hours of operation.

To check the brake adjustment, measure the distance from the stationary brake pedal to the point where there is resistance in the pedal movement. The distance must be between 6 mm (0.25 in) and 19 mm (0.75 in). Adjust the brakes if required.

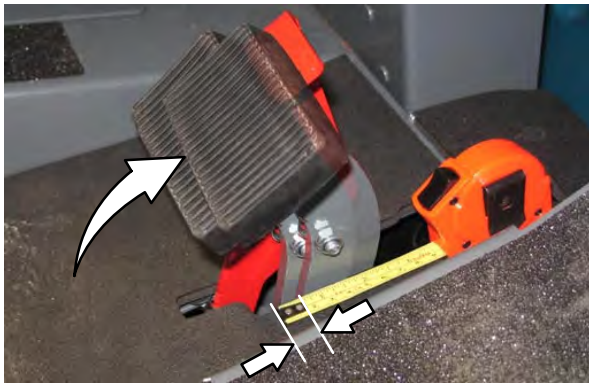

## PROPELLING MOTOR

Torque the shaft nut to 508 Nm (375 ft lb) lubricated, 644 Nm (475 ft lb) dry, after every 800 hours of operation.



### TIRES

Check tires for damage and wear after every 100 hours of operation.

### FRONT WHEEL

Torque the front wheel nuts twice in the pattern shown to 122 to 149 Nm (90 to 110 ft lb) after the first 50 hours of operation, and after every 800 hours there after.

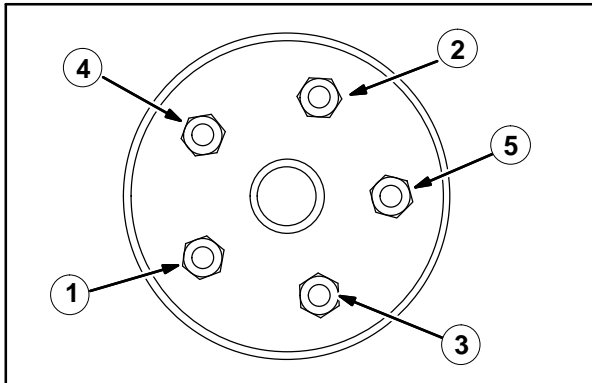

**PUSHING, TOWING, AND TRANSPORTING THE MACHINE**

**PUSHING OR TOWING THE MACHINE**

If the machine becomes disabled, it can be pushed from the front or rear, but only towed from the front.

The propelling pump has a bypass valve to prevent damage to the hydraulic system when the machine is being pushed or towed. This valve allows a disabled machine to be moved for a *very short distance* and at a speed to not exceed 1.6 kp/h (1 mph). The machine is NOT intended to be pushed or towed a long distance or at a high speed.

**ATTENTION! Do not push or tow machine for a long distance or damage may occur to the propelling system.**

Turn the bypass valve located on the bottom of the propelling pump 90° (either direction) from the normal position before pushing or towing the machine. Return the bypass valve back to the normal position when through pushing or towing the machine. **Do Not** use the bypass valve during normal machine operation.

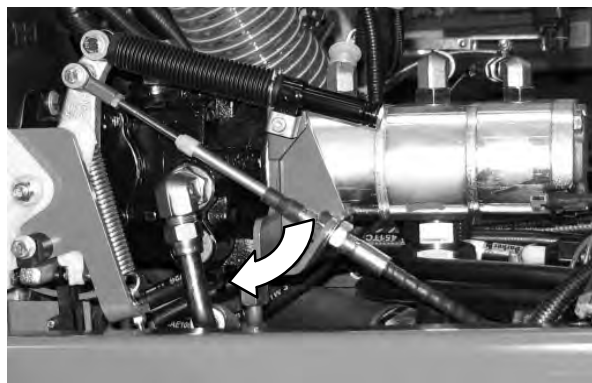
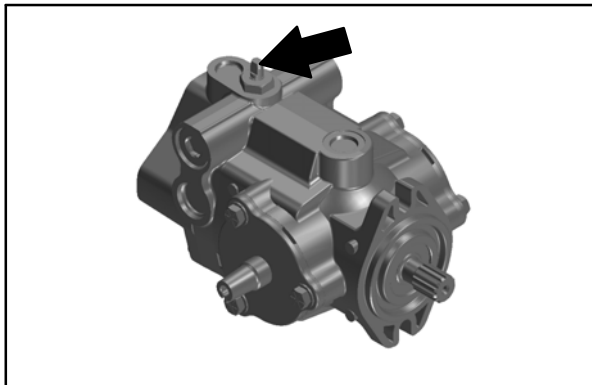

**TRANSPORTING THE MACHINE**

1. Raise the squeegee, scrub head, and brushes.

**FOR SAFETY: When loading machine onto truck or trailer, drain tanks before loading machine.**

*NOTE The machine ability to climb a ramp is affected by tire wear, ramp surface, weather conditions, and other factors. Trailing should only be performed by personnel trained on how to safely load a machine.*

2. Drive the machine onto the trailer or truck. Position the machine so the weight of the machine is safely distributed and can be safely strapped down to the trailer or truck.

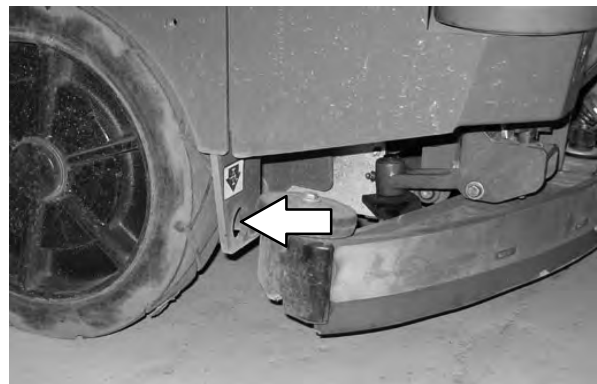

## MAINTENANCE

3. Set the parking brake and place a block behind each wheel to prevent the machine from rolling.
4. Lower the scrub head.

**FOR SAFETY: When loading/unloading machine onto/off truck or trailer, lower scrub head and squeegee before tying down machine.**

5. Connect the tie-down straps to the holes in the right and left lower corners in front of the machine and the holes in the rear jacking brackets behind the rear tires.

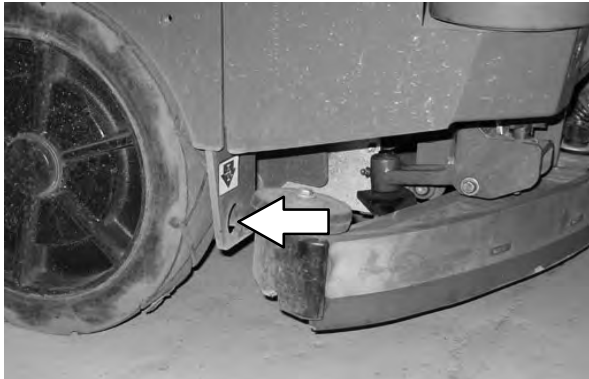

6. Route the tie-downs to the opposite ends of the machine and hook them to the brackets on the floor of the trailer or truck. Tighten the tie-down straps.

*NOTE: It may be necessary to install tie-down brackets to the floor of the trailer or truck.*

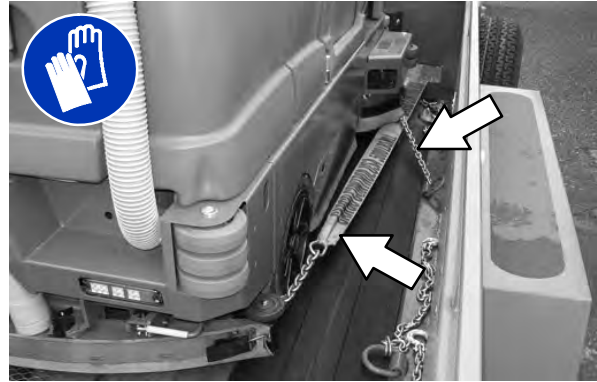

**MACHINE JACKING**

Empty the debris tray, recovery tank, and solution tank before jacking up the machine. Jack up the machine at the designated locations. Use a hoist or jack capable of supporting the weight of the machine. Use jack stands to support the machine. Always stop the machine on a flat, level surface and block the tires before jacking up the machine.

Rear jacking locations are located directly behind the rear tires on each side of the machine.

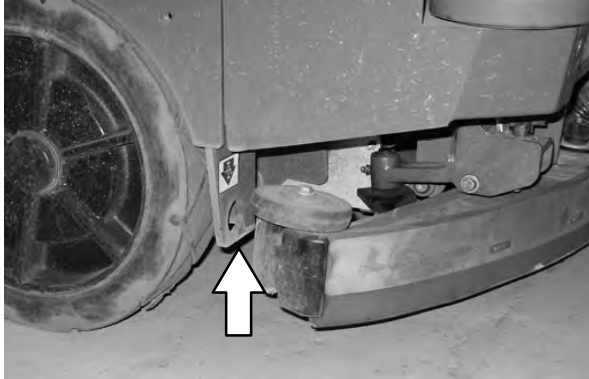

Front jacking locations are located on the frame directly in front of the front tire.

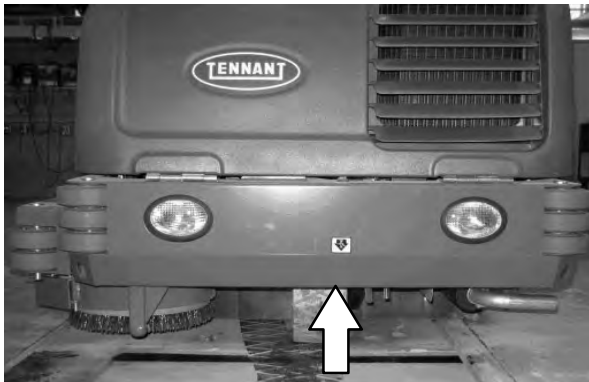

**FOR SAFETY:** Before leaving or servicing machine, stop on level surface, set parking brake, turn off machine, and remove key.

**FOR SAFETY:** When servicing machine, block machine tires before jacking machine up. Use a hoist or jack that will support the weight of the machine. Jack machine up at designated locations only. Support machine with jack stands.

**STORAGE INFORMATION**

The following steps should be taken prior to storing the machine for extended periods.

1. Drain and clean the solution and recovery tanks. Open the recovery tank and solution tank covers to allow the air to circulate.
2. Park the machine in a cool, dry area. Do not expose the machine to rain. Store indoors.
3. Remove the battery, or charge battery every three months.

## MAINTENANCE

### FREEZE PROTECTION (MACHINES WITHOUT ec-H2O SYSTEM)

**FOR SAFETY: Before leaving or servicing machine, stop on level surface, set parking brake, and turn off machine.**

1. Be sure the solution tank and recovery tank are empty.
2. Pour 3.8 L (1 gal) of Propylene Glycol Based / Recreational Vehicle (RV) Antifreeze into the solution tank.
3. **Machines with optional detergent tank only:** Pour 1.9 L (1/2 gal) of Propylene Glycol Based / Recreational Vehicle (RV) antifreeze into the detergent tank.

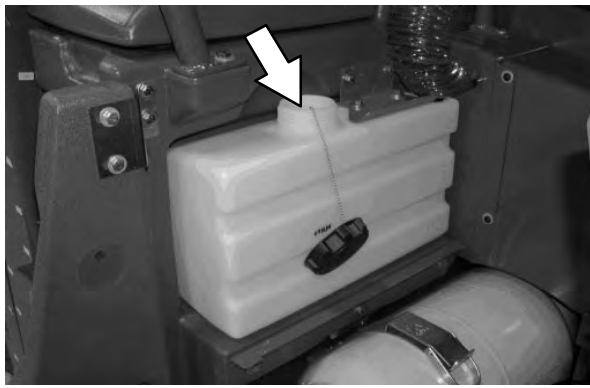

*NOTE: Machines equipped with optional ES/ Detergent Metering systems will need to fill the pump lines with Propylene Glycol Based / Recreational Vehicle (RV) antifreeze.*

4. Turn the key to the on position (**without starting the machine**).
5. Press the *scrubbing main brush button*.
6. Press the *1-STEP button*.
7. Repeatedly press the *Solution increase button (+)* until the solution flow is at the highest setting.
8. Press the *directional pedal* to circulate the RV antifreeze completely through the system.

9. **Machines with the optional detergent metering only:** Press the detergent metering button to activate the detergent metering.



10. Press the *1-STEP button* to turn off the system.

11. **Machines with the optional spray nozzle only:** Turn on the pump until RV antifreeze solution sprays from the nozzle.



12. Turn the key to the off position.
13. The remaining RV antifreeze does not need to be drained from the solution tank.

*NOTE: Storing or transporting machines equipped with the ES or the FaST system in freezing temperatures requires special procedures. Consult a TENNANT representative for more information.*

## FREEZE PROTECTION (MACHINES WITH ec-H<sub>2</sub>O SYSTEM) (S/N 000000-013000)

**FOR SAFETY: Before leaving or servicing machine, stop on level surface, set parking brake, and turn off machine.**

1. Empty the solution tank and recovery tank.
2. Remove the intake flush hose and from the storage bag behind the operator seat.
3. Disconnect the *ec-H<sub>2</sub>O* system intake hose from the solution supply hose and connect the intake flush hose (gray connector) to the *ec-H<sub>2</sub>O* system intake hose.



4. Pull the drain tube from the between the *ec-H<sub>2</sub>O* unit and the operator compartment, remove the cap from the tube, and place the end of the tube into an empty container. Set the cap aside.



5. Turn the key to the on position (**without starting the machine**).
6. Press and release the *ec-H<sub>2</sub>O* module flush switch. Allow the system to drain water into the container for 2 minutes.

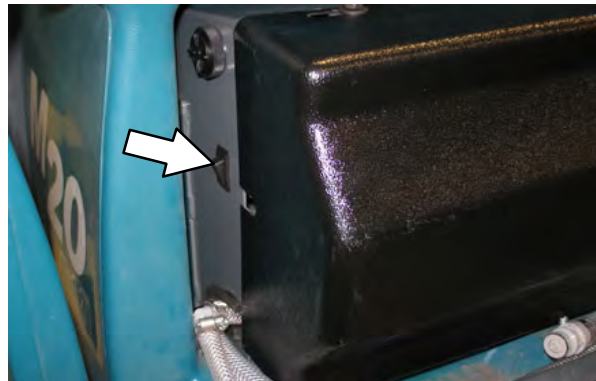

7. Press the *ec-H<sub>2</sub>O* module flush switch to shut off the system.
8. Disconnect the *ec-H<sub>2</sub>O* system outlet hose from the hose to the scrub head.



## MAINTENANCE

9. Blow pressurized air (less than 344 kPa (50 psi)) into the *ec-H2O* system outlet hose. Continue blowing compressed air into the outlet hose until water no longer drains from the drain tube

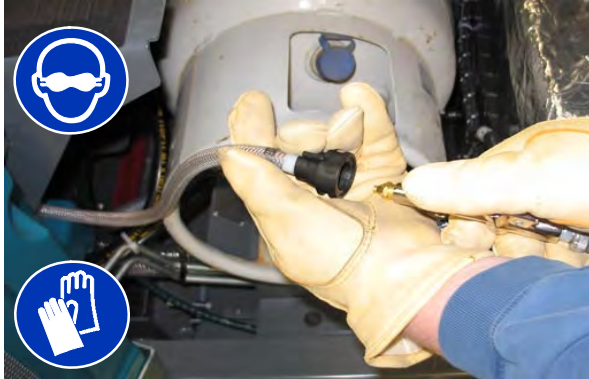

10. Reinstall the cap onto the drain tube and insert the tube back between the *ec-H2O* module and the operator compartment.
11. Reconnect the *ec-H2O* system intake hose to the solution supply hose and the *ec-H2O* system outlet hose to the hose to the scrub head.
12. Insert the intake and outlet hoses down between the *ec-H2O* assembly and the bracket.



13. Return the intake flush hose to the storage bag behind the operator seat.

**FREEZE PROTECTION (MACHINES WITH ec-H2O SYSTEM) (S/N 013001- )**

**FOR SAFETY: Before leaving or servicing machine, stop on level surface, set parking brake, and turn off machine.**

1. Empty the solution tank and recovery tank.
2. Pour 3.8 L (1 gal) of Propylene Glycol Based / Recreational Vehicle (RV) Antifreeze into the solution tank.
3. Turn the key to the on position (**without starting the machine**).
4. Press the *scrubbing main brush button*.
5. Press the *1-STEP button*.
6. Repeatedly press the *Solution increase button (+)* until the solution flow is at the highest setting.
7. Press the *directional pedal* to circulate the RV antifreeze completely through the system.
8. Press the *1-STEP button* to turn off the system.
9. **Machines with the optional spray nozzle only:** Turn on the pump until RV antifreeze solution sprays from the nozzle.



10. Turn the key to the off position.
11. The remaining RV antifreeze does not need to be drained from the solution tank.

## MAINTENANCE

### FREEZE PROTECTION (MACHINES WITH HIGH PRESSURE WASHER OPTION)

**FOR SAFETY:** Before leaving or servicing machine, stop on level surface, set parking brake, and turn off machine.

*NOTE: This procedure is only to be performed after the rest of the machines solution system has been freeze protected.*

1. Ensure there is Propylene Glycol Based / Recreational Vehicle (RV) Antifreeze remaining in the solution tank. Add more if necessary.
2. Start the machine.

*NOTE: The high pressure washer will not operate unless the parking brake is set.*

3. Verify that the *1-STEP Scrub button* is off.
4. Press the *engine speed button* to increase the engine RPM.
5. Press the top of the *Pressure washer switch* to turn on pressure washer system..



6. Operate the pressure washer for a few seconds to drain water from the pump. Release the trigger for a few more seconds which will drain any water from the return line and fill it with antifreeze.
7. Press the bottom of the *pressure washer switch* to turn off the pressure washer switch.
8. Turn off the machine.

## PREPARING THE MACHINE FOR OPERATION AFTER STORAGE

All antifreeze must be completely cleaned from the scrubbing system before the machine can be used for scrubbing.

**FOR SAFETY: Before leaving or servicing machine, stop on level surface, turn off machine, and set parking brake.**

1. Completely drain all antifreeze from the solution tank.
2. Rinse out the solution tank. Refer to *DRAINING AND CLEANING THE SOLUTION TANK* in the *OPERATION* section for instructions how to clean the solution tank.
3. Pour 11.4 L (3 gal) of cool clean water into the solution tank.
4. Machines equipped with optional detergent tank only: Pour 1.9 L (1/2 gal) of cool clean water into the detergent tank.

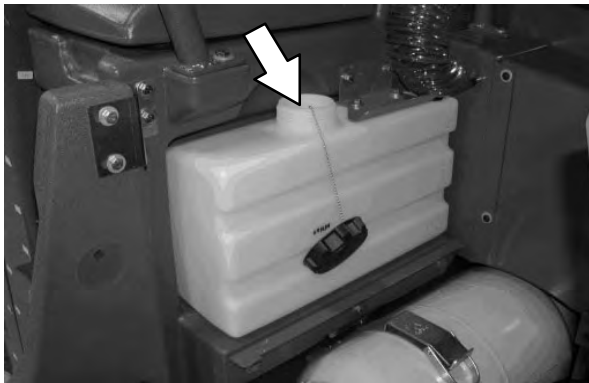

5. Start the machine.
6. Press the *1-STEP* button.
7. Repeatedly press the *Solution increase* button (+) until the solution flow is at the highest setting.
8. **Machines with severe environment switch option only:** Press the bottom of the *severe environment switch* to activate the severe environment scrubbing system.
9. **Machines with scrubbing side brush option only:** Press the *side brush* switch to activate the side brush.

10. Drive the machine until all water and antifreeze is emptied from the tanks.

*NOTE: Machines equipped with optional ES system will need to drain the antifreeze from the pump lines.*

11. Stop the machine.
12. Press the *1-STEP* button to turn off the system.
13. **Machines with spray nozzle option only:** Operate the wand for a few seconds to clean the antifreeze from the pump.
14. **Machines with high pressure washer option only:** Press the engine speed button to increase the engine RPM.

Place the return line to the solution tank into a bucket.

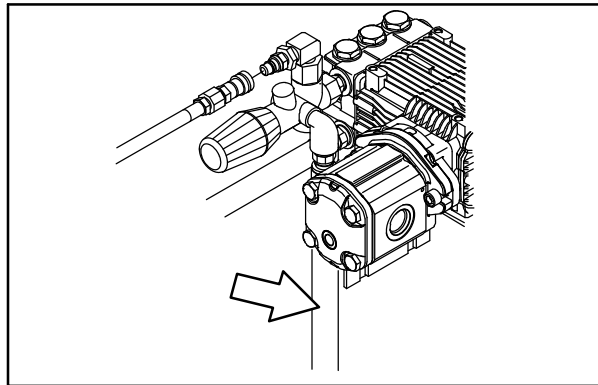

Operate the pressure washer for a few seconds to drain antifreeze from the pump. Release the trigger for a few more seconds which will drain the antifreeze from the return line into the bucket. Turn off the pressure washer switch, reduce engine speed, and place the return line back into the solution tank.

**! WARNING: Do not spray people or animals. Severe personal injury can result. Wear eye protection. Hold sprayer with two hands.**

15. Turn off the machine.

### PRIMING THE *ec-H2O* SYSTEM (MACHINES S/N 000000–013000)

Prime the *ec-H2O* system if the machine has been stored for a long period without water in the solution tank / *ec-H2O* system.

**FOR SAFETY: Before leaving or servicing machine, stop on level surface, set parking brake, and turn off machine.**

1. Fill the solution tank with clean cool water.  
See *FILLING THE SOLUTION TANK* section of this manual.
2. Remove the outlet flush hose (black connector) from the storage bag behind the operator seat.
3. Disconnect the *ec-H2O* system outlet hose from the hose to the scrub head and connect the outlet flush hose to the *ec-H2O* system outlet hose.



4. Place the *ec-H2O* system outlet hose into an empty container.
5. Turn the key to the on position (**without starting the machine**).
6. Press and release the *ec-H2O* module flush switch. Allow the system to drain water into the container for 2 minutes.
7. Press the *ec-H2O* module flush switch to shut off the system.
8. Disconnect the outlet flush hose from the *ec-H2O* system outlet hose and return the flush hose to the storage bag.
9. Reconnect the *ec-H2O* system outlet hose to the hose to the scrub head.

**SPECIFICATIONS**

**GENERAL MACHINE DIMENSIONS/CAPACITIES**

Item	Dimension/capacity
Length	2410 mm (95 in)
Height	1470 mm (58 in)
Height (with overhead guard)	2120 mm (83.5 in)
Width/frame (roller to roller)	1270 mm (50 in)
Width (rear squeegee)	1300 mm (51 in)
Width (with side brush)	1470 mm (58 in)
Wheel base	1280 mm (50.38 in)
Track	1270 mm (50 in)
Cleaning path width (main brush length)–Cylindrical Brush	1020 mm (40 in)
Cleaning path width (with scrubbing side brush)–Cylindrical Brush	1370 mm (54 in)
Cleaning path width (with sweeping side brush)–Cylindrical Brush	1420 mm (56 in)
Main brush diameter (2)–Cylindrical Brush	300 mm (12 in)
Cleaning path width (main brush length)–Disk Brush	1070 mm (42 in)
Main brush diameter (3)–Disk Brush	360 mm (14 in)
Side brush diameter–scrubbing	410 mm (16 in)
Side brush diameter–sweeping (cylindrical only)	530 mm (21 in)
Solution tank capacity	303 L (80 gallons)
Recovery tank capacity	360 L (95 gallons)
Detergent tank capacity	22.7 L (6 gallons)
Debris tray volume capacity	31 L (1.1 ft <sup>3</sup> )
Debris tray weight capacity	50 kg (110 lbs)
Weight – empty	1497 Kg (3300 lbs)
GVWR	2223 Kg (4900 lbs)
Transport ground clearance	80 mm (3 in)
Protection Grade	IPX3

Values determined as per IEC 60335–2–72	Measure
Sound pressure level $L_{pA}$	84 dB(A)
Sound uncertainty $K_{pA}$	3.0 dB(A)
Sound power level $L_{WA}$ + Uncertainty $K_{WA}$	106 dB(A)
Vibration – Hand–arm	< 2.5 m/s <sup>2</sup>
Vibration – Whole body	< 0.5 m/s <sup>2</sup>

**GENERAL MACHINE PERFORMANCE**

Item	Measure
Minimum aisle turn	2790 mm (110 in)
Travel speed forward (maximum)	12.9 Km/h (8 mph)
Travel speed reverse (maximum)	4.8 Km/h (3 mph)
Maximum ramp incline for loading – Empty tanks	10.0 deg/18%
Maximum ramp incline for scrubbing	6.0 deg/10%
Maximum ramp incline for transporting (GVWR)	8.0 deg/14%
Maximum ambient temperature for machine operation	43° C (110° F)
Minimum temperature for operating machine scrubbing functions	0° C (32° F)

# SPECIFICATIONS

## HYDRAULIC SYSTEM

System	Capacity	ISO Grade Viscosity Index	Ambient Air Temperature Ranges
Hydraulic reservoir	38 L (10 gal)	ISO 100 VI 126 or higher	19° C (65° F) or higher
Hydraulic total	45 L (12 gal)	ISO 68 VI 155 or higher	7 to 43° C (45 to 110° F)
		ISO 32 VI 163 or higher	16° C (60° F) or lower

## POWER TYPE

Engine	Type	Ignition	Cycle	Aspiration	Cylinders	Bore	Stroke
Kubota V1505-B	Piston	Diesel	4	Natural	4	78 mm (3.07 in)	78.4 mm (3.09 in)
	Displacement		Tennant governed power			Gross intermittent power per J1995	
	1500 cc (91.4 cu in)		18.5 kw (24.8 hp) @ 2300 rpm			18.5 kw (24.8 hp) @ 2300 rpm	
	Fuel		Cooling system			Electrical system	
	Diesel Fuel tank: 42 L (11.2 gal) low sulfur fuel content less than 500 ppm only		Water/ethylene glycol antifreeze			12 V nominal	
			Total: 7.5 L (2 gal)			37 A alternator	
			Radiator: 3.8 L (1 gal)				
	Idle speed, no load		(Fast) governed speed, under load			Engine lubricating oil without filter	
950 ± 50 rpm		2400 ± 50 rpm			6 L (6.35 qt) API diesel classification Cf or better		

## BRAKING SYSTEM

Type	Operation
Service brakes	Mechanical drum brakes (2), one per rear wheel, cable actuated
Parking brake	Utilize service brakes, cable actuated

## TIRES

Location	Type	Size
Front (1)	Solid	140 mm x 460 mm (5.5 in x 18 in)
Rear (2)	Solid	90 mm x 410 mm (3.5 in x 16 in)

## STEERING

Type	Power source
Front wheel, hydraulic cylinder and rotary valve controlled	Hydraulic accessory pump

**CONVENTIONAL SCRUBBING**

Item	Measure
Solution pump (S/N 000000-013000)	Gravity N/A
Solution pump (S/N 013001- )	12 Volt DC, 11A, 3.6 GPM, 45PSI Max
Solution flow rate – main scrub head (S/N 000000-013000)	2.46 LPM (0.65 GPM) – Low
	9.46 LPM (2.5 GPM) – High
Solution flow rate – main scrub head (S/N 013001- )	2.7 LPM (0.7 GPM) – Low
	9.1 LPM (2.4 GPM) – High
Solution flow rate – side brush (S/N 000000-013000)	0.87 LPM (0.23 GPM) – Low
	1.43 LPM (.38 GPM) – High
Solution flow rate – side brush (S/N 013001- )	0.75 LPM (0.20 GPM) – Low
	1.51 LPM (.40 GPM) – High

**ec-H2O SYSTEM**

Item	Measure
Solution pump (S/N 000000-013000)	12 Volt DC, 11A, 0.7 GPM & 1.4 GPM flow, (2 speeds), 75 psi high-pressure shutdown
Solution pump (S/N 013001- )	12 Volt DC, 11A, 3.6 GPM, 45PSI Max
Solution flow rate – main scrub head (S/N 000000-013000)	2.65 LPM (0.7 GPM) – Low
	5.30 LPM (1.4 GPM) – High
Solution flow rate – main scrub head (S/N 013001- )	1.9 LPM (0.5 GPM) – Low
	4.5 LPM (1.2 GPM) – High
Solution flow rate – side brush (S/N 000000-013000)	0.79 LPM (0.21 GPM) – Low
	0.87 LPM (.38 GPM) – High
Solution flow rate – side brush (S/N 013001- )	1.13 LPM (0.30 GPM) – Low
	1.32 LPM (.32 GPM) – High

**FaST SYSTEM**

Item	Measure
Solution pump	12 Volt DC, 11A, 0.7 GPM & 1.4 GPM flow, (2 speeds), 75 psi high-pressure shutdown
Low solution flow rate	2.7 LPM (0.7 GPM)
High solution flow rate	5.4 LPM (1.4 GPM)
Low concentrate flow rate	2.6 CC/Minute (0.085 Liquid Ounces/Minute)
High concentrate flow rate	5.2 CC/Minute (0.17 Liquid Ounces/Minute)

# SPECIFICATIONS

## DETERGENT METERING SYSTEM

Item	Measure
Solution pump	12 Volt DC, 125MI/Min Max, 20PSI Max
Solution flow rate	38CC/Min (1.3 Fl Oz/Min) – Low
	174CC/Min (5.9 Fl Oz/Min) – High

## MACHINE DIMENSIONS

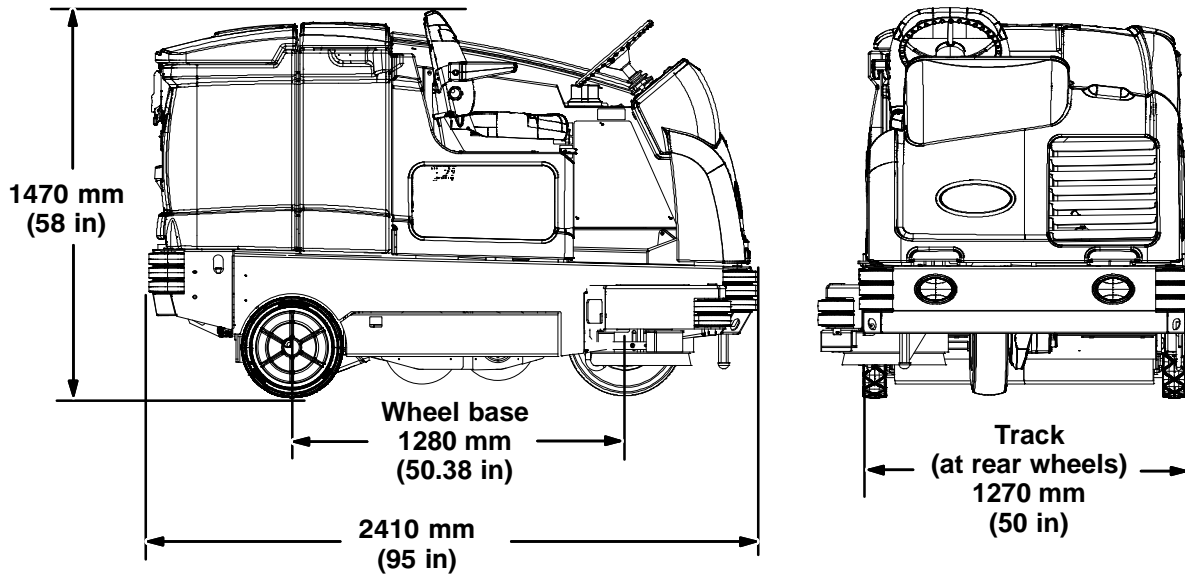
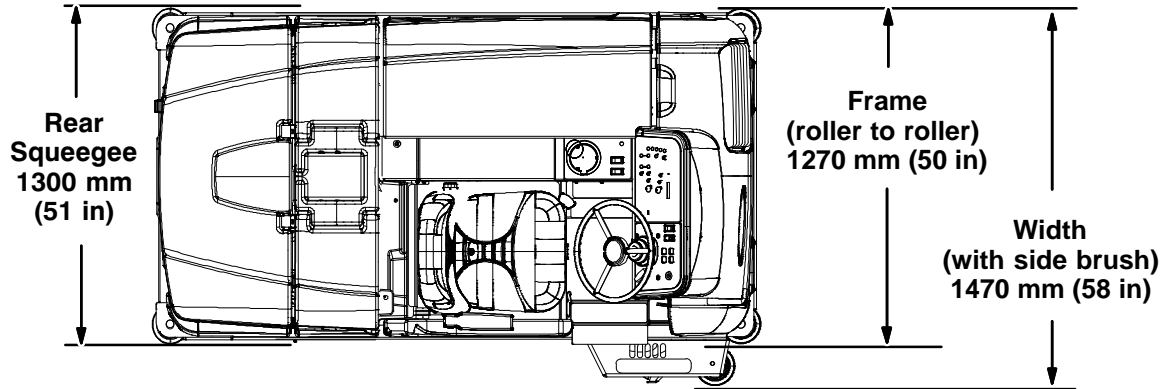

**SUPERVISOR CONTROLS**

**PRO-PANEL SUPERVISOR CONTROLS**

The supervisor controls feature allows a supervisor to program the machine scrubbing settings for operator use. The lockout functionality will prevent the operator from changing or saving the settings.

The supervisor controls feature will lower machine variability for consistent, repeatable cleaning results, machine quality assurance regardless of user experience, and reduce user training requirements.

There are two types of user modes that will interface with the operator home screen:

**Operator Mode** – Capable of machine operation with permissions and restrictions controlled by the supervisor.

**Supervisor Mode** – Capable of machine operation with full use of all controls, along with configuring permissions and restrictions for the operator mode.

A new machine from the factory will automatically start in the supervisor mode with a preassigned default supervisor profile. The factory-assigned supervisor login number is “1234”. This login number is not required until it is enabled. The default supervisor profile name and login number can be changed as described in this section. If the new assigned supervisor mode login number is forgotten, please contact Tennant service.

**ENTERING THE SUPERVISOR MODE – FIRST TIME USE ONLY**

1. Turn on the machine. The main operating screen will appear in the display.
2. Press the help button to access the help screen.



3. Press the logout button.



4. Use the keypad to enter the factory assigned supervisor login number 1234 into the display above the keypad. Press the enter button when finished entering the supervisor login number.

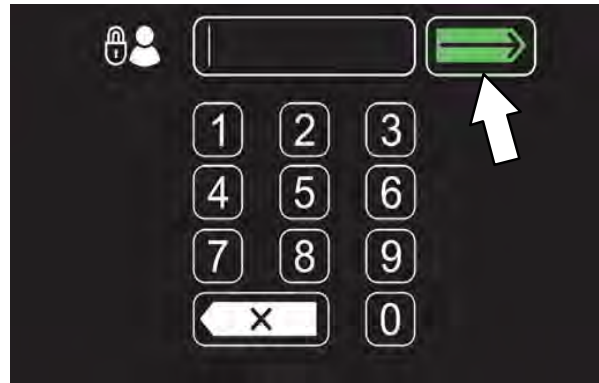

 Press the backspace button if necessary to delete and reenter a number.

5. The supervisor machine operation screen should appear in the display. Press the settings button to access the supervisor settings screen.





6. Proceed to *ADDING / EDITING PROFILES*.

## SUPERVISOR CONTROLS

### ENTERING THE SUPERVISOR MODE

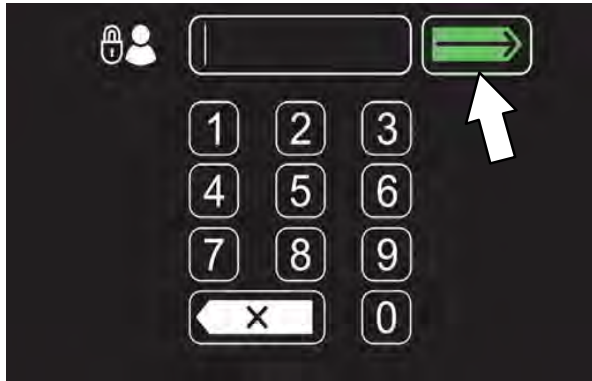
1. Turn on the machine. The login screen will appear on the display.
2. Use the keypad to enter the supervisor login number into the display above the keypad. Press the enter button when finished entering the supervisor login number.



 Press the backspace button if necessary to delete and reenter a number.

3. The supervisor machine operation screen should appear in the display. Press the settings button to access the supervisor settings screen.



## SUPERVISOR SETTING SCREEN / SCREEN ICONS

Use the supervisor maintenance screen to setup / change user passwords, user machine settings, and other machine setup items.

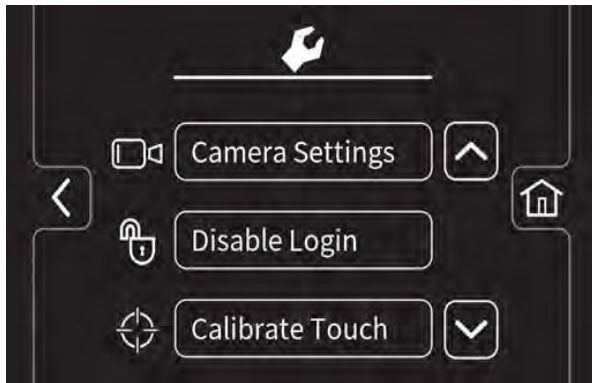
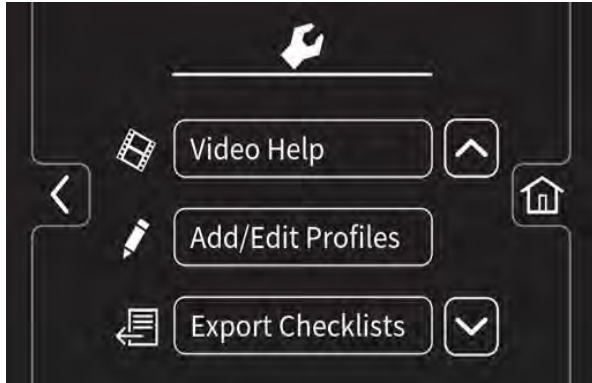

Use the below menu buttons to access the various supervisor setup menus / screens.



Press the video help button to access the various machine help videos.



Press the Add / Edit Profiles button to add, delete, and / or change machine user and supervisor profiles. See *ADDING / EDITING PROFILES*.



Press the Export Checklists button to access the Export Checklists menu. See *EXPORTING CHECKLISTS*.



Press the Checklists Setup button to access the Checklist Setup menu. See *DISABLING / ENABLING THE PREOPERATION CHECKLIST*.



Press the Date / Time Set button to set the machine date and time. See *SETTING / CHANGING THE DATE AND TIME*.



Press the Camera Settings button to access the Camera Settings screen. See *CHANGING REARVIEW CAMERA SETTINGS*.



Press the Enable Login button to activate a required login number at machine start up for all user profiles to operate machine.



Press the Disable Login button to deactivate a login number at machine start up for all user profiles to operate machine. See *DISABLING LOGIN*



Press the Calibrate Touch button to calibrate the touch screen if the touch points become misaligned.



Press the up arrow button to navigate up through the menu items.



Press the down arrow button to navigate down through the menu items.



Press the home button to navigate back to the main operating screen.



Press the back button to navigate back to the previous screen.

# SUPERVISOR CONTROLS





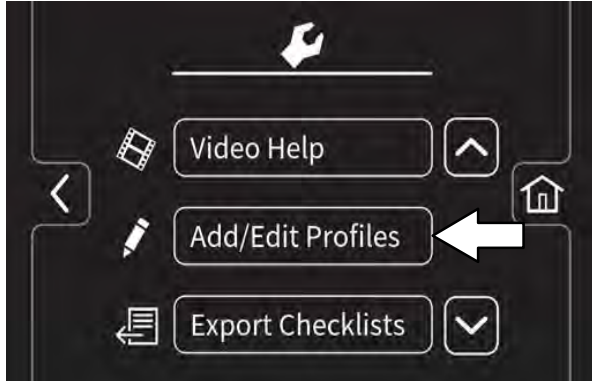

## ADDING / EDITING PROFILES

1. Turn on the machine, log into the supervisor screen, and press the settings button to access the supervisor settings screen. See *ENTERING THE SUPERVISOR MODE*.
2. Press the Add/Edit Profiles button to access the Add/Edit Profiles screen.



3. Press the Add Profile button to access the Add Profile screen.





-  Press the Add Profile button to access the screens and menus to add a new profile.
-  Press the Edit Profile button to edit an existing profile.
-  Press the Copy Profile button to copy an existing profile.
-  Press the Delete Profile button to delete an existing profile.
-  Press the home button to navigate back to the main operating screen.
-  Press the back button to navigate back to the previous screen.

4. Press the Operator button to add a new operator, or Supervisor button to add a new supervisor.



*NOTE: The default supervisor cannot be deleted from the profile list.*

-  Press the Operator button to add / edit / copy / delete an operator profile.
-  Press the Supervisor button to add / edit / copy / delete a supervisor profile.

5. Use the keypad to enter the new user / supervisor name. Press the enter button.



- Use the keypad to assign the new user / supervisor a login number. The new login number can be any combination of numbers ranging from 3 to 8 digits in length. Press the enter button.





 Press the backspace button if necessary to delete and reenter a number.

- Select the controls the new user should have access to use. Green represents unlocked controls and gray represents locked controls. Press the flashing save button to save the new profile.

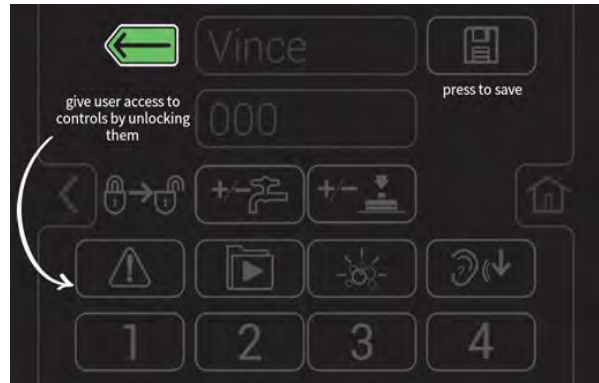

 Press the help button to access the help screen.



 Press the back button to return to the user access page.

- The new user profile is now saved to the operator profile list. Multiple operator and supervisor user profiles can be added. Press the back arrow button to return to the previous screen to add more user profiles or to enable login.
- To enable the login number at start up, press the Enable Login button.

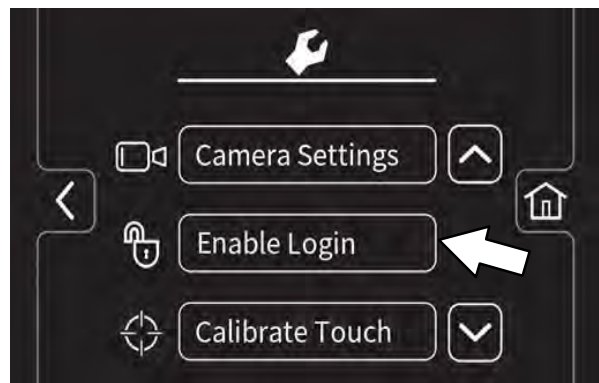

The Enable Login button will change from Enable Login to Disable Login. See *DISABLING LOGIN* for instructions how to disable login.

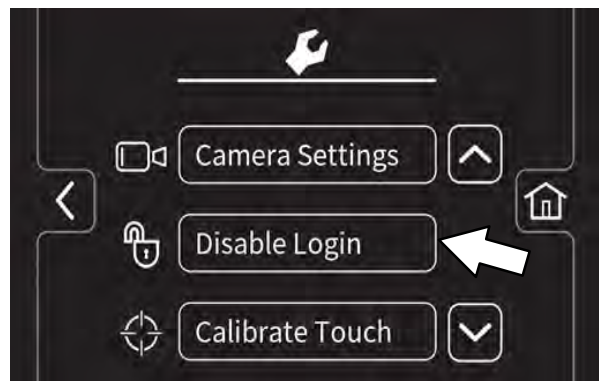

## SUPERVISOR CONTROLS

10. Now at machine start up, a login screen will display. The new user will need to enter their assigned login number to operate machine.
11. When the user is done operating the machine, it is recommended the user log out by pressing the help button, and then pressing the logout button. Turning the key to the off position is another way to also logout.
12. Use the Edit Profile button, Copy Profile button, and Delete Profile button to manage the current user profiles.

### ENABLING THE LOGIN

1. Turn on the machine, log into the supervisor screen, and press the settings button to access the supervisor settings screen. See *ENTERING THE SUPERVISOR MODE*
2. Press the Enable Login button.

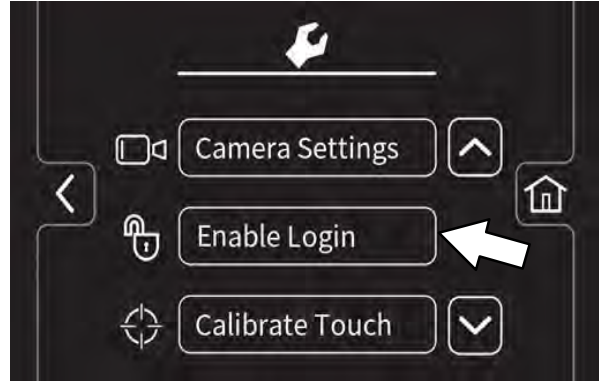

3. Press the yes button to enter the Default User screen.

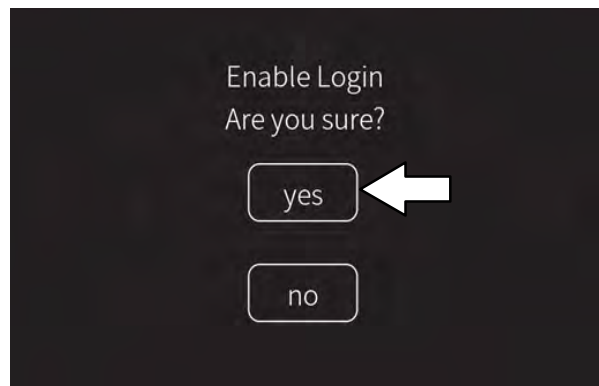

4. Press either the Operator button or Supervisor button to select the desired default user.

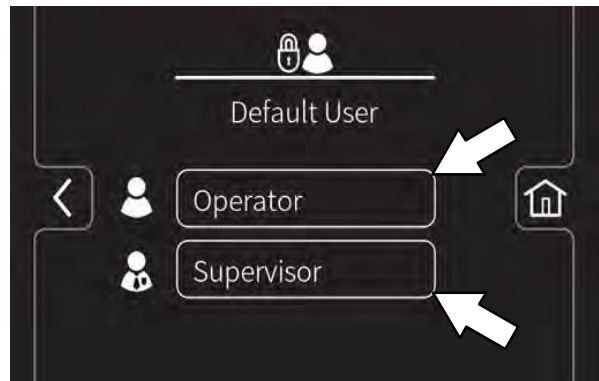

## DISABLING THE LOGIN

1. Turn on the machine, log into the supervisor screen, and press the settings button to access the supervisor settings screen. See *ENTERING THE SUPERVISOR MODE*
2. Press the Disable Login button.

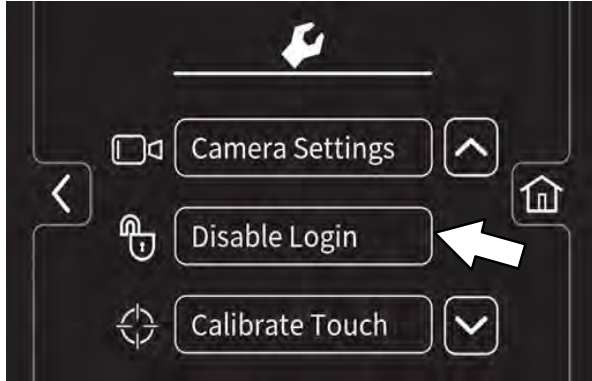

3. Press the yes button to enter the Default User screen.

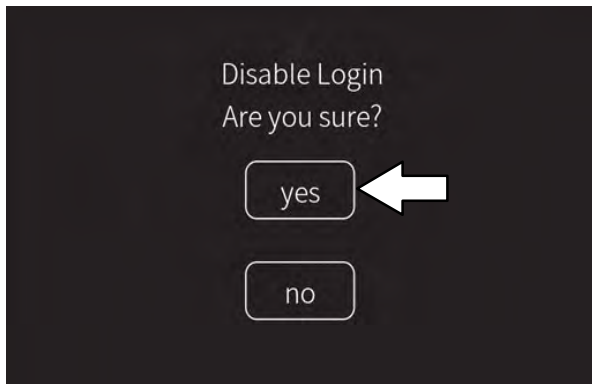

4. Press either the Operator button or Supervisor button to select the desired default user.

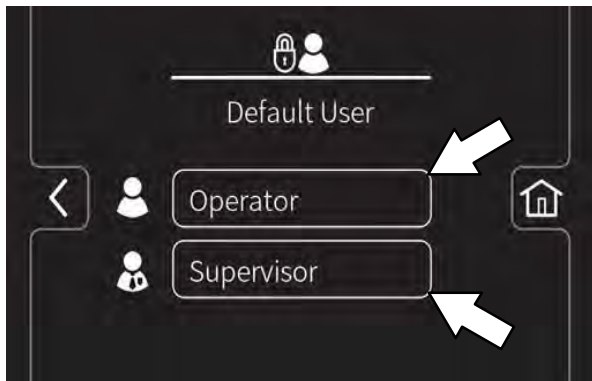

5. Select a pre-assigned user profile. Turn off the machine to apply the setting.

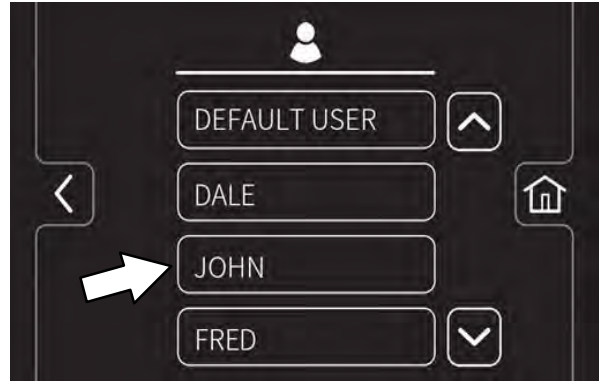

6. At start up, the home screen is now set without a login requirement for the operator profile as the default.

## CALIBRATING THE TOUCH

1. Turn on the machine, login to the main operation screen, and press the setting button to access the supervisor settings screen. See *ENTERING THE SUPERVISOR MODE*
2. Press the Calibrate Touch button to recalibrate touch if the touch points become misaligned.

# SUPERVISOR CONTROLS

## EXPORTING CHECKLISTS

Exporting the checklists allows the checklists to be exported from the machine and to a flash drive.

1. Turn on the machine, log into the supervisor screen, and press the settings button to access the supervisor settings screen. See *ENTERING THE SUPERVISOR MODE*
2. Plug the flash drive into the USB port.



3. Press the Export Checklists button to access the export screen.

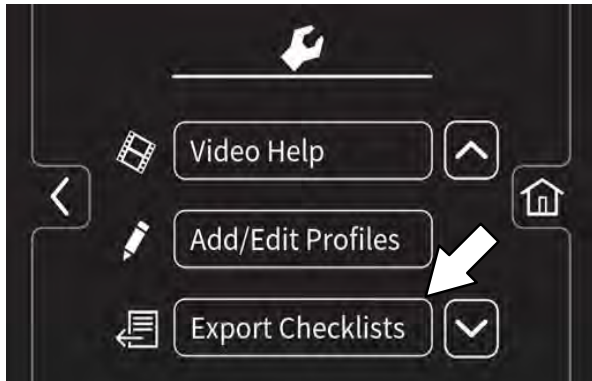

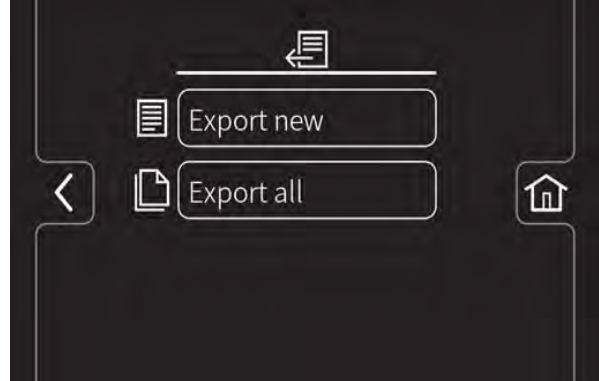

4. Export the Pre-Operation Checklists from the machine to the memory stick.



 Press the Export New button to export the newly completed Pre-Operation Checklists from the machine.

*NOTE: All checklists that have not been previously exported are flagged.*

 Press the Export All button to export all completed Pre-Operation Checklists from the machine.

 Press the home button to navigate back to the main operating screen.

 Press the back button to navigate back to the previous screen.

5. Remove the flash drive from USB port and turn off the machine.

## CHECKLIST SETUP

Checklist setup allows the checklist to be setup / changed to meet machine usage demands.



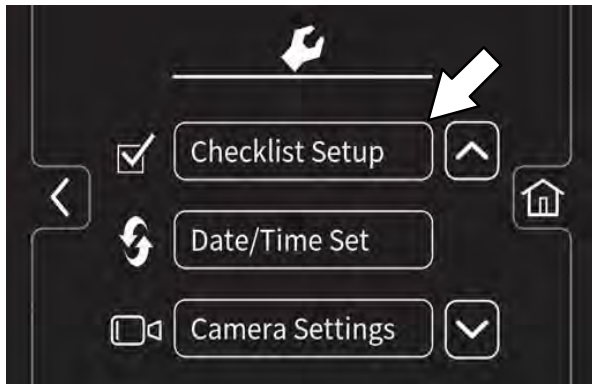

1. Turn on the machine, login to the main operation screen, and press the setting button to access the supervisor settings screen. See *ENTERING THE SUPERVISOR MODE*.
2. Press the Checklist Setup button to access the Pre-Operation checklist setup screen.

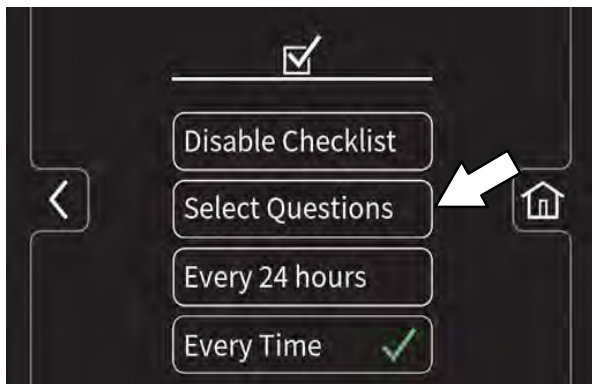



3. Press the Select Questions button to access the Pre-Operation Checklist master list screen.

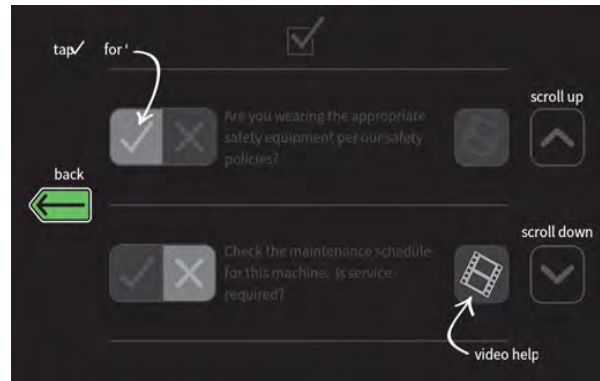

 Press the down arrow button to scroll down through Pre-Operation Checklist items.

-  Press the up arrow button to scroll up through Pre-Operation Checklist items.
-  Press the check box button to select a new checklist item to add to the checklist.
-  Press either the video help button to view the video related to a particular Pre-Operation Checklist item.
-  Press the Enter button to add the selected Pre-Operation Checklist items(s) to the Pre-Operation Checklist.
-  Press the help button to access the Pre-Operation Checklist help screen.



 Press the back button to return to the Pre-Operation Checklist Master List screen.

4. Press the Every 24 hours button or the Every Time button to set the interval the operator must complete the Pre-Operation Checklist. A check mark appears in the chosen interval.

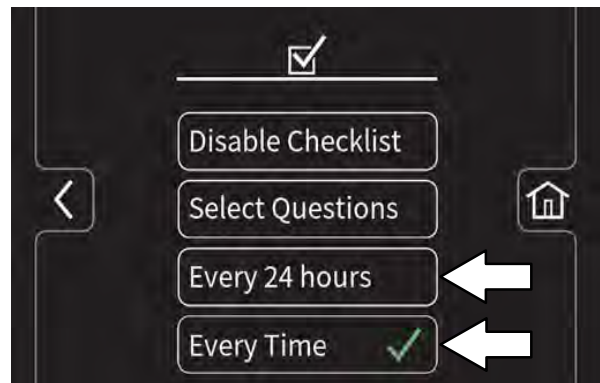

 Press the home button to navigate back to the main operating screen.

 Press the back button to navigate back to the previous screen.

## SUPERVISOR CONTROLS

### DISABLING / ENABLING THE PRE-OPERATION CHECKLIST

Disabling / enabling the Pre-Operation checklist allows the Pre-Operation checklist to be disabled if it is not necessary for the operator to complete the checklist prior to operating the machine and enabled if it is necessary for the operator to complete the checklist prior to operating the machine.

1. Turn on the machine, login to the main operation screen, and press the setting button to access the supervisor settings screen. See *ENTERING THE SUPERVISOR MODE*.
2. Press the Checklist Setup button to access the Pre-Operation checklist setup screen.

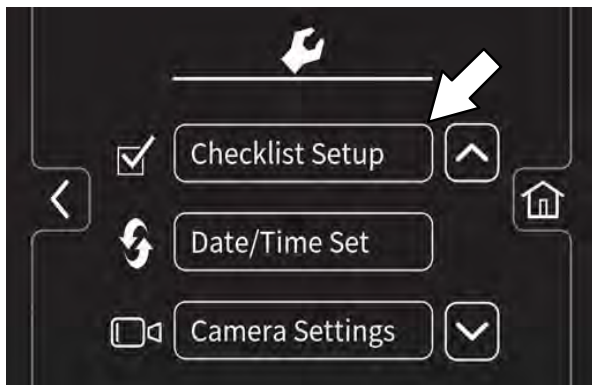

3. Press the Disable Checklist button / Enable Checklist button to disable / enable the Pre-Operation Checklist.

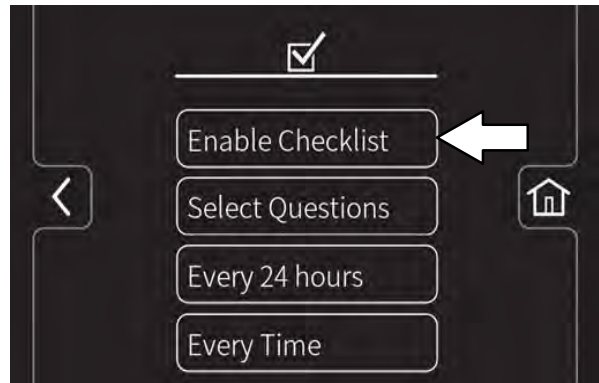
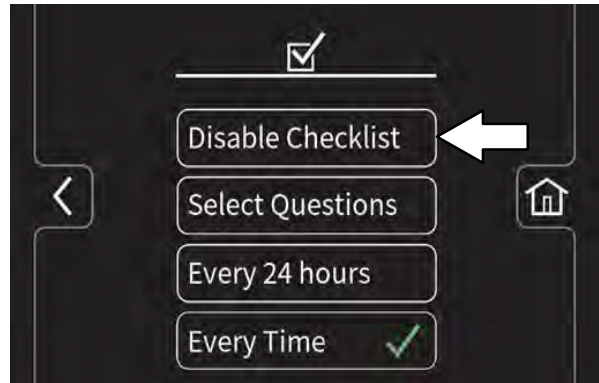

 Press the home button to navigate back to the main operating screen.





 Press the back button to navigate back to the previous screen.

## CHANGING THE REAR VIEW CAMERA SETTINGS

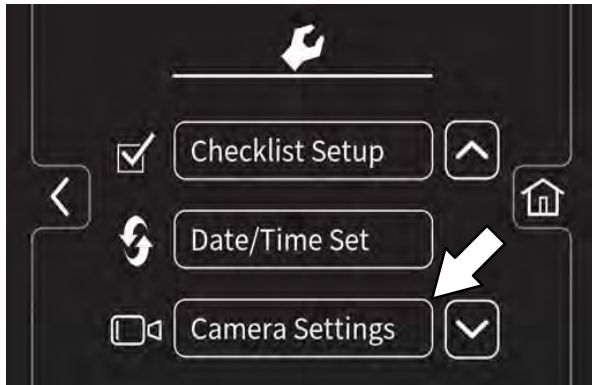
Changing the rear view camera settings allows the time the rear view camera remains on when the *rear view camera button* is pushed to be changed. The rear view camera can be set to any time between 5 seconds and 15 seconds.

1. Turn on the machine, log into the main operation screen, and press the setting button to access the supervisor settings screen. See *ENTERING THE SUPERVISOR MODE*.
2. Press the *Camera Settings button* to access the rear view camera settings screen.



-  Press the *increase button* to increase the time the rear view camera remains on when the operator presses the *rearview camera button*.
-  Press the *decrease button* to decrease the time the rear view camera remains on when the operator presses the *rearview camera button*.
-  Press the home button to navigate back to the main operating screen.
-  Press the back button to navigate back to the previous screen.

## PROGRAMMING THE ZONE CONTROL BUTTONS

Programming the zone control buttons allows the parameters for the zone control buttons to be changed / updated to meet scrubbing / sweeping demands.

1. Turn on the machine, log into the supervisor screen, and press the setting button to access the supervisor settings screen. See *ENTERING THE SUPERVISOR MODE*.
2. Use the *brush pressure increase (+) button* and the *brush pressure decrease (-) button* to set the zone brush pressure.



3. Use the *solution increase (+) button* and the *solution decrease (-) button* to set the zone solution flow level.



## SUPERVISOR CONTROLS

4. Press and hold the zone control button until the “name preset” screen appears.









6. Use the key pad to enter the name for the zone control button.



5. Press the yes button to set the zone settings. Press the no button to return to the main operating screen.



-  Press the home button to navigate back to the main operating screen.
-  Press the back button to navigate back to the previous screen.
-  Press the enter button to set the zone button name.
-  Press the backspace button if necessary to delete and reenter a number.
-  Press the space button to place space between letters / numbers..
-  Press the pound button to toggle between the number keypad and the letter keypad.

7. Press the enter button to set the zone button settings. The main operating screen returns to the display with the zone button named. The brush pressure and solution flow setting also briefly appear in the display.









## SETTING / CHANGING THE DATE AND TIME

Setting / changing the date and time allow the system date and time to be set / changed.

1. Turn on the machine, login to the main operation screen, and press the setting button to access the supervisor settings screen. See *ENTERING THE SUPERVISOR MODE*
2. Press the *Date/Time Set button* to access the date / time screen.



-  Press the *date button* to change the system date
-  Press the *time button* to change the system time.
-  Press the *toggle button* to toggle between hours, minutes, and AM / PM on the time screen and the month, day, and year on the date screen.
-  Press the *increase button* advance the time / date parameters
-  Press the *decrease button* to reverse the time / date parameters.
-  Press the *home button* to navigate back to the main operating screen.
-  Press the *back button* to navigate back to the previous screen.

3. Press the *home button* when finished setting / changing the system date and time to return to the main operating screen..

